

# GH15 Series IEC Motor Controls

The GH15 series of IEC contactors and thermal overload relays are manufactured by Europe's leading maritime contactor company. Contactors for ocean-going vessels are built to the most rigid specifications. This same design technology carries over to this line of industrial motor controls.

We offer individual components that allow you to use the contactor alone or to assemble your motor starter using our thermal overload relays. You can also combine a manual motor starter/protector for all-in-one protection.

Use contactors wherever you need a heavy-duty switching device with up to three poles. Add up to 2 side-mounted auxiliary blocks (1 per side) plus 1 top-mounted auxiliary contact block per contactor max. This will equal up to 8 possible auxiliary contact configurations. Or use the optional mechanical interlock to create an inexpensive reversing contactor.

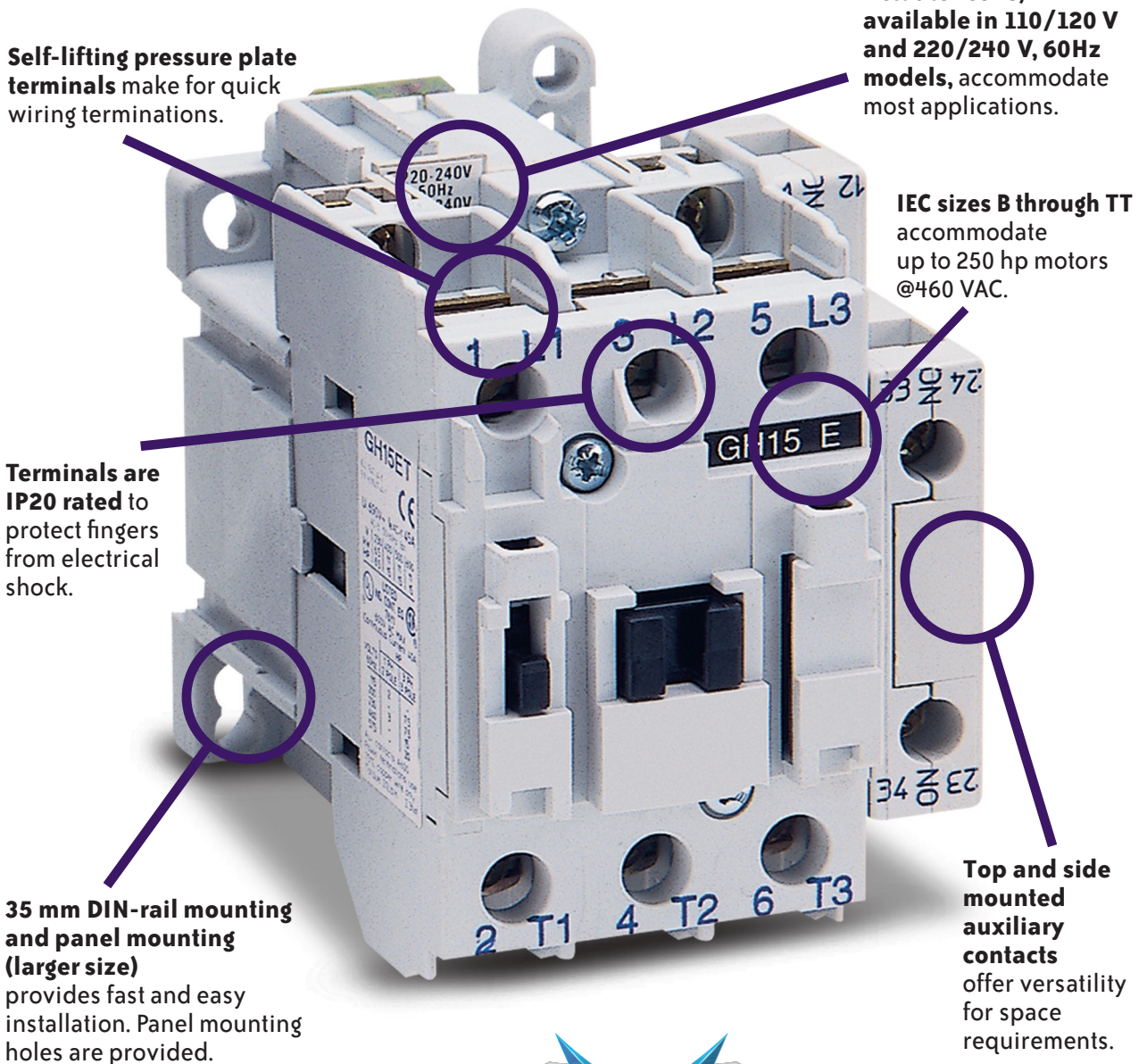

**Self-lifting pressure plate terminals** make for quick wiring terminations.

**Actuator coils, available in 110/120 V and 220/240 V, 60Hz models,** accommodate most applications.

**IEC sizes B through TT** accommodate up to 250 hp motors @460 VAC.

**Terminals are IP20 rated** to protect fingers from electrical shock.

**35 mm DIN-rail mounting and panel mounting (larger size)** provides fast and easy installation. Panel mounting holes are provided.

**Top and side mounted auxiliary contacts** offer versatility for space requirements.



**Approvals**

- cULus listed #E191059
- UL 60947-4-1A



See next page for detailed specifications.

# GH15 Series Contactor Configurations

Contactor Configurations							
IEC FRAME SIZE	Contactor Model*	Part Number	Price	Number of Contacts			Coil Voltage and Frequency
				Main	Auxiliary Contacts Included		
					N.O	N.C.	
45 mm	GH15BN	GH15BN-3-10A	\$45.50	3	1	–	110-120 VAC 50-60 Hz
		GH15BN-3-01A	\$44.50	3	–	1	110-120 VAC 50-60 Hz
		GH15BN-3-10B	\$45.50	3	1	–	220-240 VAC 50-60 Hz
		GH15BN-3-01B	\$44.50	3	–	1	220-240 VAC 50-60 Hz
	GH15CN	GH15CN-3-10A	\$52.00	3	1	–	110-120 VAC 50-60 Hz
		GH15CN-3-01A	\$52.00	3	–	1	110-120 VAC 50-60 Hz
		GH15CN-3-10B	\$52.00	3	1	–	220-240 VAC 50-60 Hz
		GH15CN-3-01B	\$52.00	3	–	1	220-240 VAC 50-60 Hz
	GH15DN	GH15DN-3-10A	\$57.00	3	1	–	110-120 VAC 50-60 Hz
		GH15DN-3-01A	\$57.00	3	–	1	110-120 VAC 50-60 Hz
		GH15DN-3-10B	\$57.00	3	1	–	220-240 VAC 50-60 Hz
		GH15DN-3-01B	\$57.00	3	–	1	220-240 VAC 50-60 Hz
	GH15ET	GH15ET-3-00A	\$84.75	3	–	–	110-120 VAC 50-60 Hz
		GH15ET-3-00B	\$84.75	3	–	–	220-240 VAC 50-60 Hz
	GH15FT	GH15FT-3-00A	\$92.75	3	–	–	110-120 VAC 50-60 Hz
		GH15FT-3-00B	\$92.75	3	–	–	220-240 VAC 50-60 Hz
60 mm	GH15GT	GH15GT-3-00A	\$168.25	3	–	–	120 VAC 60 Hz only
		GH15GT-3-00B	\$75.25	3	–	–	240 VAC 60 Hz / 212 VAC 50 Hz
	GH15HT	GH15HT-3-00A	\$186.75	3	–	–	120 VAC 60 Hz only
		GH15HT-3-00B	\$186.75	3	–	–	240 VAC 60 Hz / 212 VAC 50 Hz
	GH15JT	GH15JT-3-00A	\$194.75	3	–	–	120 VAC 60 Hz only
		GH15JT-3-00B	\$194.75	3	–	–	240 VAC 60 Hz / 212 VAC 50 Hz
79 mm	GH15KT	GH15KT-3-00A	\$240.75	3	–	–	120 VAC 60 Hz only
		GH15KT-3-00B	\$240.75	3	–	–	240 VAC 60 Hz / 212 VAC 50 Hz
	GH15LT	GH15LT-3-00A	\$284.50	3	–	–	120 VAC 60 Hz only
		GH15LT-3-00B	\$284.50	3	–	–	240 VAC 60 Hz / 212 VAC 50 Hz
	GH15MT	GH15MT-3-00A	\$317.25	3	–	–	110-120 VAC 50-60 Hz / 110 VDC
		GH15MT-3-00B	\$317.25	3	–	–	220-240 VAC 50-60 Hz
110 mm	GH15NT	GH15NT-3-00A	\$419.25	3	–	–	110-120 VAC 50-60 Hz / 110 VDC
		GH15NT-3-00B	\$419.25	3	–	–	220-240 VAC 50-60 Hz / 220 VDC
	GH15PT	GH15PT-3-00A	\$507.00	3	–	–	110-120 VAC 50-60 Hz / 110 VDC
		GH15PT-3-00B	\$507.00	3	–	–	220-240 VAC 50-60 Hz / 220 VDC
145 mm	GH15RT	GH15RT-3-00A	\$633.50	3	–	–	110-120 VAC 50-60 Hz / 110 VDC
		GH15RT-3-00B	\$633.50	3	–	–	220-240 VAC 50-60 Hz / 220 VDC
	GH15ST	GH15ST-3-00A	\$674.25	3	–	–	110-120 VAC 50-60 Hz / 110 VDC
		GH15ST-3-00B	\$674.25	3	–	–	220-240 VAC 50-60 Hz / 220 VDC
	GH15TT	GH15TT-3-00A	\$869.00	3	–	–	110-120 VAC 50-60 Hz / 110 VDC
		GH15TT-3-00B	\$869.00	3	–	–	220-240 VAC 50-60 Hz / 220 VDC

\* Up to 2 auxiliary contact blocks may be added to the contactor by utilizing the side mount and top mount contact block assemblies. Though referred to as a top mount assembly, the GH15T mounts to the front of the contactor.

Note: If using the BMOH or BM3H-AD mechanical interlock, the use of auxiliary contacts is prohibited on the side of each contactor where the interlock is mounted. This does not pertain to the auxiliary contact built into the GH15BN, GH15CN and GH15DN contactors.

# GH15 Series 45 mm Contactor Specifications

45 mm Contactor Specifications								
Contactor Model			GH15BN	GH15CN	GH15DN	GH15ET	GH15FT	
<b>Insulation Voltage</b>	AC	(V)	600 Volts AC					
<b>Ampere Rating UL 508</b>	Max. UL Continuous Current	(A)	11	14	19	32	32	
	Max. UL General Use Current <small>note 2</small>	(A)	20	20	25	40	45	
<b>Maximum Power (hp) of Three-Phase Motors</b>	200V	(hp)	2	3	3	7.5	7.5	
	230/240V	(hp)	3	3	5	7.5	10	
	460/480V	(hp)	5	7.5	10	15	20	
	575V	(hp)	7.5	10	15	20	25	
<b>Maximum Power (hp) of Single-Phase Motors</b>	115V	(hp)	0.5	0.5	1	2	2	
	230/240V	(hp)	1	2	3	3	5	
<b>Insulation Voltage</b>	AC	(V)	690 Volts AC					
<b>Ampere Rating EN/IEC 60947</b>	AC-3 Ie (ambient Temp = 55°C @ 440V)	(A)	9	12	16	25	32	
	AC-1 Ie (ambient Temp = 40°C @ 690V)	(A)	30	30	30	45	50	
<b>Maximum Power (kW) of Three-Phase Motors AC3 Category <small>note 1</small></b>	230/240V	(kW)	2.2	3	4	6.5	7.5	
	400V	(kW)	4	5.5	7.5	11	15	
	440/480V	(kW)	4.7	6.4	9	12.5	16.5	
	500V	(kW)	5.5	7.5	10	11	15	
	690V	(kW)	5.5	7.5	7.5	11	15	
<b>Max Short Circuit Protection Fuses Class RK5 UL Rated Fuses</b>	Type 2 Coordination <small>note 3</small>	(A)	25	30	50	60	70	
<b>SCCR Rating (kA)</b>		kA	5	5	5	5	5	
Auxiliary Contacts Electrical Capacity			A600 <small>note 4</small>					
Coil Voltage Operating Limits			AC Pick-up 85-110% rated control voltage / AC Drop-out 20-75% rated control voltage					
Average Coil Power Requirements / Coil current (A) = VA/Coil Voltage			AC Pick-Up (VA) 80-100 / AC Sealed (VA) 9-12					
Power Factor			Pick-up 0.65 / Sealed 0.35					
Coil Operating Time at Rated Coil Voltage			Pick-up (ms) 10-25 / Drop-out (ms) 6-18					
Maximum Operating Frequency (No-Load Operation)			3000 operations / hour					
Mechanical Durability			10,000,000 operations					
Operating Ambient Temperature			-25 to +70C (-13 to +158F)					
Electrical Protection Degree			IP20 (IP10 for power entry cables)					
Mounting			Screw (panel mount) or 35mm DIN rail					
Main Circuit Connections	Wire Size		14-10 AWG Stranded			14-8 AWG Stranded		
	Tightening Torque		1.4 N·m (12 lb·in)			2.3 N·m (20 lb·in)		
Auxiliary Circuit Connections	Wire Size		16-12 AWG Stranded / 14-12 AWG Solid					
	Tightening Torque		0.8 N·m (7 lb·in)					

**Notes**

1. AC3 type loads consist of squirrel cage three phase motors.
2. AC1 non-inductive or slightly inductive loads. Typically resistive loads (i.e. furnaces, ovens, etc.)
3. Type 2 coordination is a protection category for IEC 60947-4-1. Section 8.2.5.1 specifies that Type 2 coordination requires that, under short circuit conditions, the contactor or starter shall cause no danger to persons or installations, and shall be suitable for further use. The risk of minor contact welding is possible.
4. NEMA ICS 5-2000. For more information, refer to Control Circuit Contact Electrical Ratings.

## Contactor Diagram

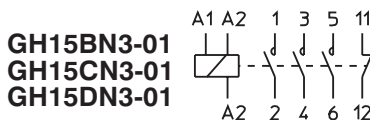
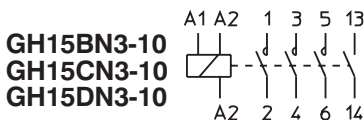

# GH15 Series 60 mm Contactor Specifications

60 mm Contactor Specifications					
Contactor Model			<i>GH15GT</i>	<i>GH15HT</i>	<i>GH15JT</i>
<b>Insulation Voltage</b>	AC	(V)	600 Volts AC		
<b>Ampere Rating UL 508</b>	Max. UL Continuous Current	(A)	42	52	65
	Max. UL General Use Current <small>note 2</small>	(A)	60	70	80
<b>Maximum Power (hp) of Three-Phase Motors</b>	200V	(hp)	10	15	15
	230/240V	(hp)	10	15	20
	460/480V	(hp)	25	30	40
	575V	(hp)	30	40	50
<b>Maximum Power (hp) of Single-Phase Motors</b>	115V	(hp)	3	3	5
	230/240V	(hp)	5	7.5	10
<b>Insulation Voltage</b>	AC	(V)	690 Volts AC		
<b>Ampere Rating EN/IEC 60947</b>	AC-3 Ie (ambient Temp = 55°C @440V)	(A)	40	50	63
	AC-1 Ie (ambient Temp = 40°C @690V)	(A)	63	80	100
<b>Maximum Power (kW) of Three-Phase Motors AC3 Category <small>note 1</small></b>	230/240V	(kW)	11	12.5	18.5
	400V	(kW)	18.5	22	30
	440/480V	(kW)	21	25	33
	500V	(kW)	18.5	22	30
	690V	(kW)	18.5	22	30
<b>Max Short Circuit Protection Circuit Breaker UL Rated MCCB</b>	Type 2 Coordination <small>note 3</small>	(A)	150	175	200
<b>SCCR Rating (kA)</b>		(kA)	5	5	5
Auxiliary Contacts Electrical Capacity			A600 <small>note 4</small>		
Coil Voltage Operating Limits			AC Pick-up 85-110% rated control voltage AC Drop-Out 20-75% rated control voltage		
Average Coil Power Requirements / Coil current (A) = VA/Coil Voltage			AC Pick-up (VA) 250 / AC Sealed (VA) 18		
Power Factor			Pick-up 0.54 / Sealed 0.35		
Coil Operating Time at Rated Coil Voltage			Pick-up (ms) 12-30 / Drop-out (ms) 6-15		
Maximum Operating Frequency (No-Load Operation)			3000 operations / hour		
Mechanical Durability			10,000,000 operations		
Operating Ambient Temperature			-25 to +70C (- 13 to +158F)		
Electrical Protection Degree			IP20 (IP10 for power entry cables)		
Mounting			Screw (panel mount) or 35mm DIN rail		
Main Circuit Connections	Wire Size		12-3 AWG stranded		
	Tightening Torque		5.0 N·m (45 lb·in)		
Auxilliary Circuit Connections	Wire Size		16-12 AWG (stranded recommended)		
	Tightening Torque		0.8 N·m (7 lb·in)		

**Notes**

1. AC3 type loads consist of squirrel cage three phase motors.
2. AC1 non-inductive or slightly inductive loads. Typically resistive loads (i.e. furnaces, ovens, etc.)
3. Type 2 coordination is a protection category for IEC 60947-4-1. Section 8.2.5.1 specifies that Type 2 coordination requires that, under short circuit conditions, the contactor or starter shall cause no danger to persons or installations, and shall be suitable for further use. The risk of minor contact welding is possible.
4. NEMA ICS 5-2000. For more information, refer to Control Circuit Contact Electrical Ratings.

## Contactor Diagram

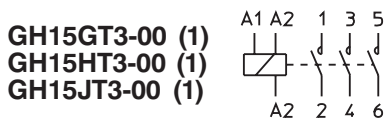



# GH15 Series 79 mm Contactor Specifications

79 mm Contactor Specifications					
Contactor Model			GH15KT	GH15LT	GH15MT
<b>Insulation Voltage</b>	AC	(V)	600 Volts AC		
<b>Ampere Rating UL 508</b>	Max. UL Continuous Current	(A)	90	90	120
	Max. UL General Use Current <small>note 2</small>	(A)	90	100	120
<b>Maximum Power (hp) of Three-Phase Motors</b>	200V	(hp)	20	25	30
	230/240V	(hp)	25	30	40
	460/480V	(hp)	50	60	75
	575V	(hp)	60	75	100
<b>Maximum Power (hp) of Single-Phase Motors</b>	115V	(hp)	5	7.5	10
	230/240V	(hp)	15	15	20
<b>Insulation Voltage</b>	AC	(V)	1000 Volts AC		
<b>Ampere Rating EN/IEC 60947</b>	AC-3 Ie (ambient Temp = 55°C @440V)	(A)	80	95	110
	AC-1 Ie (ambient Temp = 40°C @690V)	(A)	125	125	135
<b>Maximum Power (kW) of Three-Phase Motors AC3 Category <small>note 1</small></b>	230/240V	(kW)	22	25	30
	400V	(kW)	37	45	55
	440/480V	(kW)	45	51	63
	500V	(kW)	45	51	55
	690V	(kW)	45	51	55
<b>Max Short Circuit Protection Fuses Class RK5 UL Rated Fuses</b>	Type 2 Coordination <small>note 3</small>	(A)	250	250	225
<b>SCCR Rating (kA)</b>		(kA)	10	10	10
Auxiliary Contacts Electrical Capacity			A600 <small>note 4</small>		
Coil Voltage Operating Limits			AC Pick-up 85-110% rated control voltage AC Drop-Out 20-75% rated control voltage		
Average Coil Power Requirements / Coil current (A) = VA/Coil Voltage			AC Pick-up (VA) 250 / AC Sealed (VA) 18		AC Pick-up (VA) 250 AC Sealed 24-125V (VA) 4 AC Sealed 220-600V (VA) 19
Power Factor			Pick-up 0.54 / Sealed 0.35		Pick-up 0.98 Sealed 24-125V 0.98 Sealed 220-600V 0.2
Coil Operating Time at Rated Coil Voltage			Pick-up (ms) 12-30 / Drop-out (ms) 6-15		Pick-up (ms) 15-50 Drop-out (ms) 30-80
Maximum Operating Frequency (No-Load Operation)			3000 operations / hour		
Mechanical Durability			10,000,000 operations		
Operating Ambient Temperature			-25 to +70C (- 13 to +158F)		
Electrical Protection Degree			IP20 (Front)		
Mounting			Screw (panel mount)		
Main Circuit Connections	Wire Size		10-2 AWG Stranded (1 or 2 wires)		
	Tightening Torque		8.0 N-m (70 lb-in)		
Auxiliary Circuit Connections	Wire Size		2 x 16-12 AWG Stranded / 2 x 14-12 AWG Solid		
	Tightening Torque		0.8 N-m (7 lb-in)		

**Notes**

- AC3 type loads consist of squirrel cage three phase motors.
- AC1 non-inductive or slightly inductive loads. Typically resistive loads (i.e. furnaces, ovens, etc.)
- Type 2 coordination is a protection category for IEC 60947-4-1. Section 8.2.5.1 specifies that Type 2 coordination requires that, under short circuit conditions, the contactor or starter shall cause no danger to persons or installations, and shall be suitable for further use. The risk of minor contact welding is possible.
- NEMA ICS 5-2000. For more information, refer to Control Circuit Contact Electrical Ratings.

## Contactor Diagram

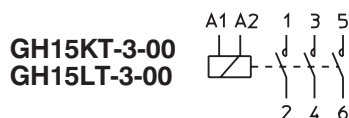

# GH15 Series 110 mm Contactor Specifications

110 mm Contactor Specifications				
<b>Contactor Model</b>			<b>GH15NT</b>	<b>GH15PT</b>
<b>Insulation Voltage</b>	AC	(V)	600 Volts AC	
<b>Ampere Rating UL 508</b>	Max. UL Continuous Current	(A)	180	180
	Max. UL General Use Current <small>note 2</small>	(A)	180	220
<b>Maximum Power (hp) of Three-Phase Motors</b>	200V	(hp)	40	50
	230/240V	(hp)	50	60
	460/480V	(hp)	100	125
	575V	(hp)	125	150
<b>Maximum Power (hp) of Single-Phase Motors</b>	115V	(hp)	15	15
	230/240V	(hp)	25	30
<b>Insulation Voltage</b>	AC	(V)	1000 Volts AC	
<b>Ampere Rating EN/IEC 60947</b>	AC-3 Ie (ambient Temp = 55°C @440V)	(A)	150	175
	AC-1 Ie (ambient Temp = 40°C @690V)	(A)	230	250
<b>Maximum Power (kW) of Three-Phase Motors AC3 Category <small>note 1</small></b>	230/240V	(kW)	40	50
	400V	(kW)	75	90
	440/480V	(kW)	85	100
	500V	(kW)	90	110
	690V	(kW)	110	132
<b>Max Short Circuit Protection Fuses Class RK5 UL Rated Fuses</b>	Type 2 Coordination <small>note 3</small>	(A)	300	350
<b>SCCR Rating (kA)</b>		(kA)	10	10
Auxiliary Contacts Electrical Capacity			A600 <small>note 4</small>	
Coil Voltage Operating Limits			AC Pick-up 85-110% rated control voltage AC Drop-Out 20-75% rated control voltage	
Average Coil Power Requirements / Coil current (A) = VA/Coil Voltage			AC Pick-up (VA) 350 / AC Sealed (VA) 5	
Power Factor			Pick-up 0.98 / Sealed 0.98	
Coil Operating Time at Rated Coil Voltage			Pick-up (ms) 30-60 / Drop-out (ms) 30-80	
Maximum Operating Frequency (No-Load Operation)			1200 operations / hour	
Mechanical Durability			10,000,000 operations	
Operating Ambient Temperature			-25 to +70C (- 13 to +158F)	
Electrical Protection Degree			IP00 - IP20	
Mounting			Screw (panel mount)	
Main Circuit Connections with Terminal Kit MR3-AD	Wire Size		2 x 4/0 AWG Stranded / 1 x 4/0 AWG Solid	
	Tightening Torque		17 N-m (150 lb-in)	
Auxiliary Circuit Connections	Wire Size		2 X 5-4/0 AWG Stranded	
	Tightening Torque		0.8 N-m (7 lb-in)	

**Notes**

1. AC3 type loads consist of squirrel cage three phase motors.
2. AC1 non-inductive or slightly inductive loads. Typically resistive loads (i.e. furnaces, ovens, etc.)
3. Type 2 coordination is a protection category for IEC 60947-4-1. Section 8.2.5.1 specifies that Type 2 coordination requires that, under short circuit conditions, the contactor or starter shall cause no danger to persons or installations, and shall be suitable for further use. The risk of minor contact welding is possible.
4. NEMA ICS 5-2000. For more information, refer to Control Circuit Contact Electrical Ratings.

## Contactor Diagram

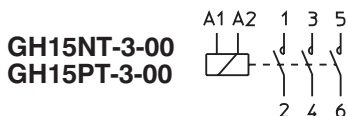

# GH15 Series 145 mm Contactor Specifications

145 mm Contactor Specifications					
Contactor Model			GH15RT	GH15ST	GH15TT
<b>Insulation Voltage</b>	AC	(V)	600 Volts AC		
<b>Ampere Rating UL 508</b>	Max. UL Continuous Current	(A)	250	300	360
	Max. UL General Use Current <small>note 2</small>	(A)	250	300	360
<b>Maximum Power (hp) of Three-Phase Motors</b>	200V	(hp)	60	75	100
	230/240V	(hp)	75	100	125
	460/480V	(hp)	150	200	250
	575V	(hp)	200	250	300
<b>Maximum Power (hp) of Single-Phase Motors</b>	230/240V	(hp)	40	50	50
<b>Insulation Voltage</b>	AC	(V)	1000 Volts AC		
<b>Ampere Rating EN/IEC 60947</b>	AC-3 le (ambient Temp = 55°C @440V)	(A)	210	260	315
	AC-1 le (ambient Temp = 40°C @690V)	(A)	350	450	500
<b>Maximum Power (kW) of Three-Phase Motors AC3 Category <small>note 1</small></b>	230/240V	(kW)	60	75	90
	400V	(kW)	110	132	160
	440/480V	(kW)	125	150	190
	500V	(kW)	132	160	210
	690V	(kW)	132	160	210
<b>Max Short Circuit Protection Fuses Class RK5 UL Rated Fuses</b>	Type 2 Coordination <small>note 3</small>	(A)	400	450	500
<b>SCCR Rating (kA)</b>		(kA)	18	18	18
Auxiliary Contacts Electrical Capacity			A600 <small>note 4</small>		
Coil Voltage Operating Limits			AC Pick-up 85-110% rated control voltage AC Drop-Out 20-75% rated control voltage		
Average Coil Power Requirements / Coil current (A) = VA/Coil Voltage			AC Pick-up (VA) 360 / AC Sealed (VA) 5		
Power Factor			Pick-up 0.98 / Sealed 0.98		
Coil Operating Time at Rated Coil Voltage			Pick-up (ms) 40-60 / Drop-out (ms) 40-60		
Maximum Operating Frequency (No-Load Operation)			1200 operations / hour		
Mechanical Durability			8,000,000 operations		
Operating Ambient Temperature			-25 to +70C (- 13 to +158F)		
Electrical Protection Degree			IP20 (Front)		
Mounting			Screw (panel mount)		
Main Circuit Connections with Terminal Kit KAL-4	Wire size		2 x 6-300 MCM (75° copper wire only)		
	Tightening Torque		31 N·m (275 lb·in)		
Auxiliary Circuit Connections	Wire Size		16-12 AWG Stranded / 14-12 AWG Solid		
	Tightening Torque		0.8 N·m (7 lb·in)		

**Notes**

- AC3 type loads consist of squirrel cage three phase motors.
- AC1 non-inductive or slightly inductive loads. Typically resistive loads (i.e. furnaces, ovens, etc.)
- Type 2 coordination is a protection category for IEC 60947-4-1. Section 8.2.5.1 specifies that Type 2 coordination requires that, under short circuit conditions, the contactor or starter shall cause no danger to persons or installations, and shall be suitable for further use. The risk of minor contact welding is possible.
- NEMA ICS 5-2000. For more information, refer to Control Circuit Contact Electrical Ratings.

## Contactor Diagram

GH15RT-3-00  
GH15ST-3-00  
GH15TT-3-00

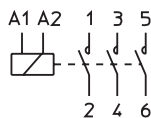

# GH15 Series Contactor Electrical Durability of Main Contacts

Main contacts have a conductor material support, on which a silver alloy tip is welded. This tip makes, carries and breaks the load currents. The contact durability is represented by the average number of operations which the contact can carry out without maintenance and before the contact requires replacement. Every operation involves mechanical

stresses when the contactor closes and thermal stress during load current conduction. However, the main stress that affects contact durability is due to the electric arc between contacts during making and breaking operations. The electric arc causes the erosion of the contact active material; such erosion will increase according to the intensity of

the current and the arcing time. Therefore the contact durability is strictly dependent on the type of load, i.e. on the utilization category, rated operational current and rated voltage. The following diagrams give curves of contact durability for each contactor for use in category AC-1, AC-3 and AC-4.

**AC-1/400V  
AC-4/400V**

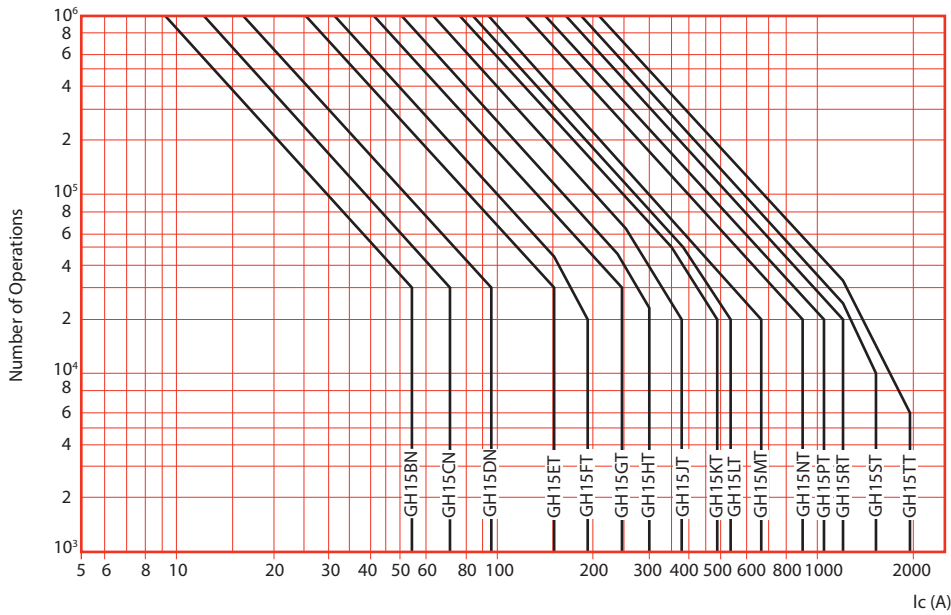

**AC-3/400V**

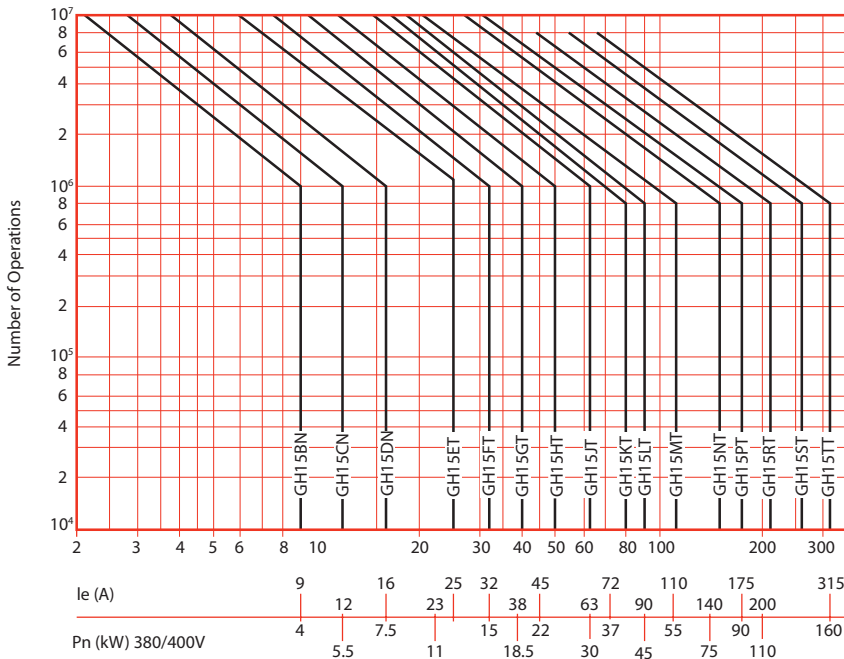

*Note: Average durability curves are at 400V.  
For higher operational voltages, reduce the durability according following table.*

Electrical Durability Curve Adjustment for Voltages Over 400V		
	AC-1 / AC-4	AC-3
<b>400V</b>	0%	0%
<b>440V</b>	10%	5%
<b>500V</b>	20%	10%
<b>690V</b>	40%	20%



# GH15 Series Contactor Dimensions

Dimensions mm [inches]									
Contactor Model	Wide	High	Deep	Mounting					Product Weight kg [lb.]
	A	B	C	D	E	E1	F	G	
GH15BN	45.0 [1.77]	80.0 [3.15]	85.0 [3.35]	35.0 [1.38]	60.0 [2.36]	7.5 [0.30]	116.0 [4.57]	12.0 [0.47]	0.41 [0.90]
GH15CN			35.0 [1.38]	60.0 [2.36]	7.5 [0.30]	116.0 [4.57]	12.0 [0.47]		
GH15DN			35.0 [1.38]	60.0 [2.36]	7.5 [0.30]	116.0 [4.57]	12.0 [0.47]		
GH15ET	45.0 [1.77]	80.0 [3.15]	91.0 [3.58]	35.0 [1.38]	60.0 [2.36]	7.5 [0.30]	122.0 [4.80]	12.0 [0.47]	0.47 [1.04]
GH15FT			35.0 [1.38]	60.0 [2.36]	7.5 [0.30]	122.0 [4.80]	12.0 [0.47]		
GH15GT			35.0 [1.38]	60.0 [2.36]	7.5 [0.30]	122.0 [4.80]	12.0 [0.47]		
GH15HT	60.0 [2.36]	114.0 [4.49]	109.0 [4.29]	50.0 [1.97]	100.0 [3.94]	—	140.0 [5.51]	12.0 [0.47]	1.12 [2.47]
GH15JT	79.0 [3.11]	137.0 [5.39]	130.0 [5.12]	70.0 [2.76]	100.0 [3.94]	—	161.0 [6.34]	12.0 [0.47]	1.80 [3.97]
GH15KT			70.0 [2.76]	100.0 [3.94]	—	161.0 [6.34]	12.0 [0.47]		
GH15LT			70.0 [2.76]	100.0 [3.94]	—	161.0 [6.34]	12.0 [0.47]		
GH15MT	79.0 [3.11]	162.0 [6.38]	130.0 [5.12]	70.0 [2.76]	100.0 [3.94]	—	161.0 [6.34]	12.0 [0.47]	2.20 [4.85]
GH15NT	110.0 [4.33]	170.0 [6.69]	162.0 [6.38]	100.0 [3.94]	130.0 [5.12]	—	193.0 [7.59]	12.0 [0.47]	4.00 [8.82]
GH15PT			100.0 [3.94]	130.0 [5.12]	—	193.0 [7.59]	12.0 [0.47]		
GH15RT			100.0 [3.94]	130.0 [5.12]	—	193.0 [7.59]	12.0 [0.47]		
GH15ST	145.0 [5.71]	200.0 [7.87]	208.0 [8.19]	120.0 [4.72]	160.0 [6.30]	—	239.0 [9.41]	12.0 [0.47]	7.50 [16.53]
GH15TT									

## GH15BN, GH15CN, GH15DN, GH15ET, GH15FT

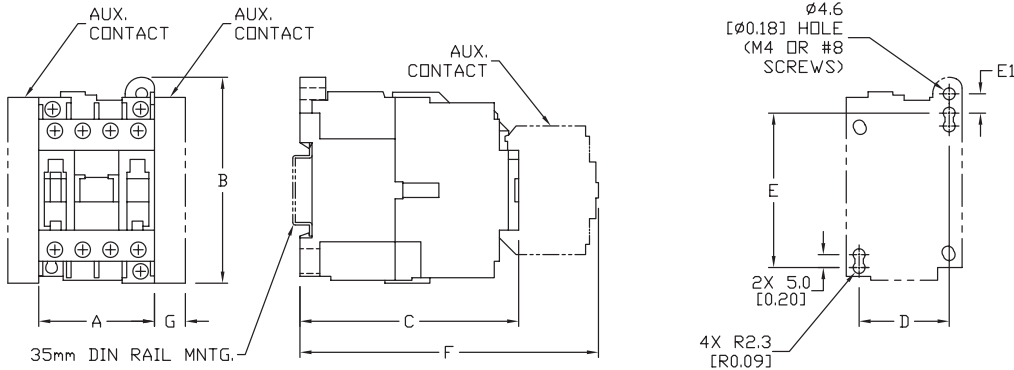

## GH15GT, GH15HT, GH15JT

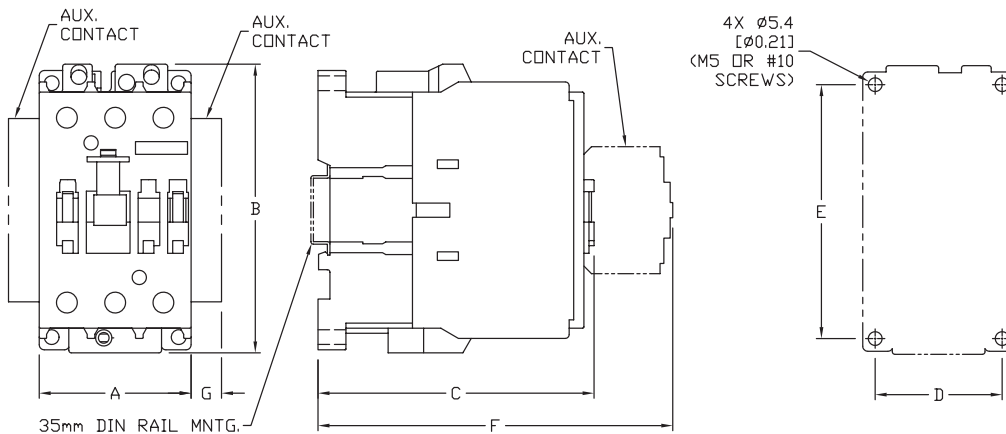

# GH15 Series Contactor Dimensions

Dimensions mm [inches]

## GH15KT, GH15LT, GH15MT

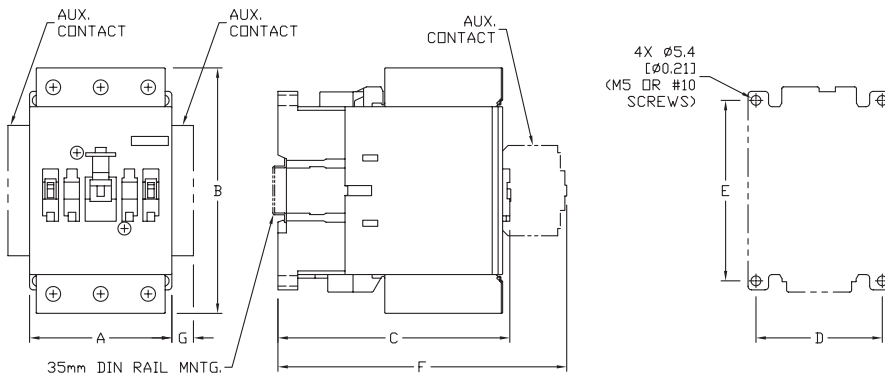

## GH15NT and GH15PT

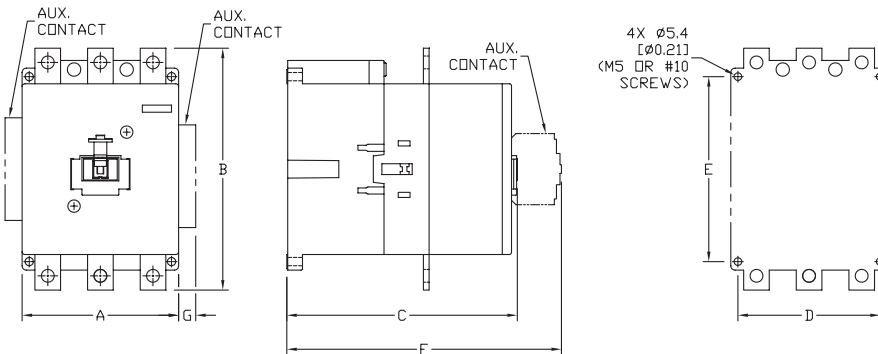

## GH15RT, GH15ST, GH15TT

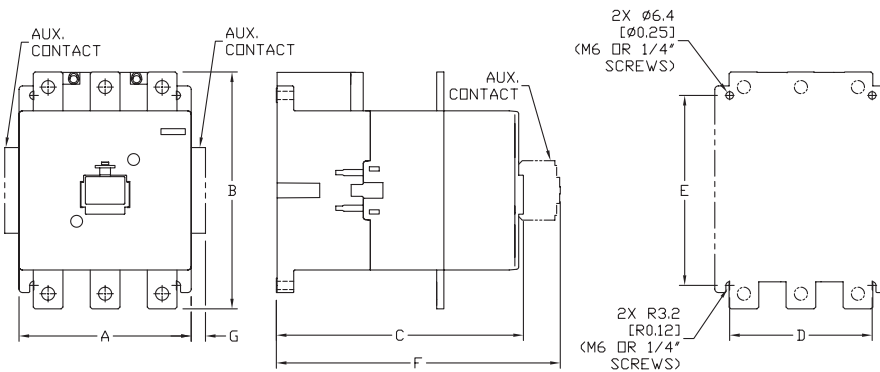

## GH15 Series Mounting Positions

The correct mounting position is with the base plate in the vertical plane. The device can be mounted up to 25° from the vertical position.

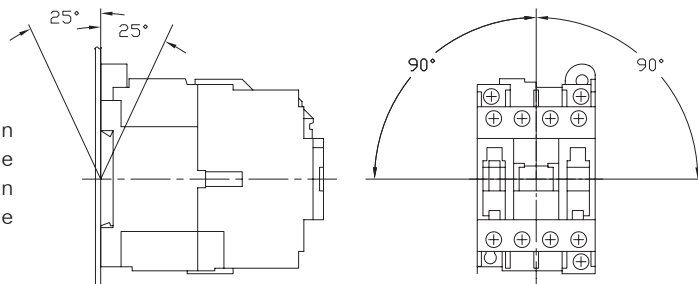

# GH15 Series Contactor Accessories

## Auxiliary contacts

Auxiliary contacts are designed for installation on all the GH15 series contactors. The snap-on design makes them quick and easy to install. The bifurcated contact blocks feature silver nickel alloy contacts.

Add up to 2 side-mounted auxiliary blocks (1 per side) plus 1 top-mounted auxiliary contact block per contactor max. This will equal up to 8 possible auxiliary contact configurations.

Auxiliary Contacts			
Part Number	Price	Description	Mounting
GH15T11	\$17.75	1 NO 1 NC	Top
GH15T22	\$26.00	2 NO 2 NC	Top
GH15T31	\$26.00	3 NO 1 NC	Top
GH15T40	\$30.00	4 NO	Top
GH15S11	\$22.50	1 NO 1 NC	Side

*Contacts rated A600 per NEMA ICS 5-2000. For more info, refer to Control Circuit Contact Electrical Ratings.*

Note: See contactor drawings page for dimensions



## Auxiliary Contact Blocks

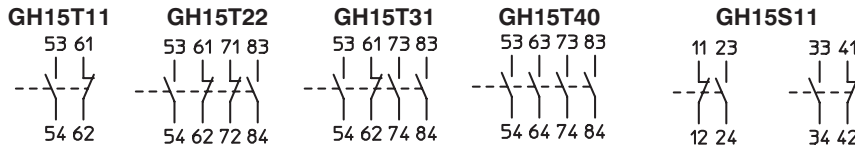

## Replacement coils

Replacement Coils			
Part Number	Price	Description	Use With
B01-A-120	\$21.50	110-120VAC 50-60Hz	GH15BN, GH15CN, GH15DN, GH15ET, GH15FT
B01-B-240	\$21.50	220-240VAC 50-60Hz	
B02-A-120	\$21.50	120VAC 60Hz	GH15GT, GH15HT, GH15JT, GH15KT, GH15LT
B02-B-240	\$15.25	240VAC 60Hz / 212VAC 50Hz	
B022-A-120	\$67.25	110-120VAC 50-60Hz, 110VDC	GH15MT
B022-B-240	\$67.25	220-240VAC 50-60Hz	
B031-A-120	\$94.75	110-120VAC 50-60Hz, 110VDC	GH15NT, GH15PT
B031-B-240	\$94.75	220-240VAC 50-60Hz, 220VDC	
B041-A-120	\$270.25	110-120VAC 50-60Hz, 110VDC	GH15RT, GH15ST, GH15TT
B041-B-240	\$270.25	220-240VAC 50-60Hz, 220VDC	

# GH15 Series Contactor Accessories

## Mechanical Interlock

Mechanical interlocks connect two contactors horizontally. When one contactor is energized, the other contactor is mechanically prohibited from making, even though it may be energized. The mechanical interlocks work with 45, 60, 79, 110 and 145 mm contactors.

### BMOH / BM3H-AD

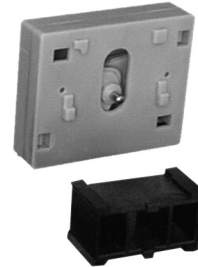

Mechanical Interlock			
Part Number	Price	Description	Mounting
<b>BMOH</b>	\$16.25	Mechanical interlock, for use with GH15BN, GH15CN, GH15DN, GH15ET, GH15FT, GH15GT, GH15HT, GH15JT, GH15KT, GH15LT, or GH15MT series contactors.	Side
<b>BM3H-AD</b>	\$25.50	Mechanical interlock, for use with GH15NT, GH15PT, GH15RT, GH15ST or GH15TT series contactors.	Side

### BMOH

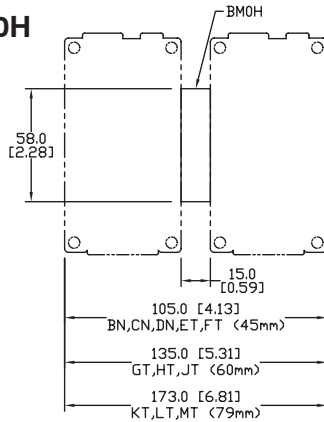

### BM3H-AD

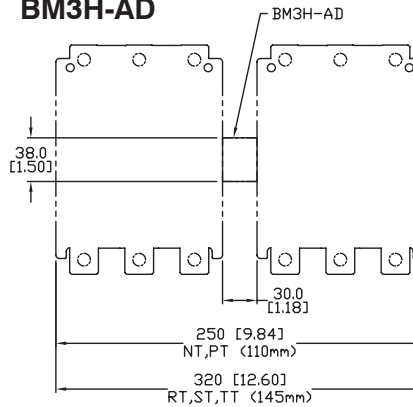

## Terminal Screens

Terminal screens are for use with contactors and thermal overload relays to protect against accidental contact with live components.

### PRT3-AD



Terminal Screens*				
Part Number	Price	Quantity	Description	Use With
<b>PR37-AD</b>	\$25.50	1 screen	Terminal screen, top or bottom, covers 3 poles. Use on line or load side. Mounting hardware included.	GH15NT GH15PT
<b>PRT3-AD</b>	\$25.00	1 screen	Terminal screen, top or bottom, covers 3 poles. Use on line or load side. Mounting hardware included.	GH15RT GH15ST GH15TT

### PR37-AD



\* No additional protecting device is required for contactors up to IEC Size 79mm since the equipment by itself ensures IP20 frontal protection.

## Terminal Lug

Part Number	Price	Quantity	Description	Use With
<b>MR3-AD</b>	\$13.00	1	Terminal lug, 1-pole, can hold (2) wires 6 AWG - 4/0 AWG.	GH15NT GH15PT RTD180
<b>KAL-4</b>	\$30.00	1	Terminal lug, 1-pole, can hold (1) wire 6 AWG - 300 MCM. Mounting hardware included.	GH15RT GH15ST GH15TT RTD320

### MR3-AD



### KAL-4



# Adjustable Overloads for GH15 Series Contactors

The RTD series adjustable motor overload relays are designed for use with the GH15 Series 45 mm, 60 mm, 79 mm, 110 mm, and 145 mm contactors.

By combining the contactor with an overload relay, you have a reliable motor starter solution.



## RTD32 overload relays for 45 mm contactors

- 16 sizes for motor currents from 0.4 to 32 amps
- Units come with (1) N.O. and (1) N.C. auxiliary contacts
- Mount directly to 45 mm contactors
- Class 10A trip class
- cULus listed, CE

## RTD65 overload relays for 60 mm contactors

- Four sizes for motor currents from 20 to 65 amps
- Units come with (1) N.O. and (1) N.C. auxiliary contacts
- Mount directly to 60 mm contactors
- Class 10A trip class
- cULus listed, CE

## RTD180 overload relays for 79 mm and 110 mm contactors

- 3 sizes for motor currents from 60 to 180 amps
- Units come with (1) N.O. and (1) N.C. auxiliary contacts
- Mount directly to 110 mm contactors with connection links (included)
- Hard-wire connection to 79 mm contactors (No connection links available)
- Class 10A trip class
- cULus listed, CE

## RTD320 overload relays for 145 mm contactors

- 2 sizes for motor currents from 144 to 320 amps
- Units come with (1) N.O. and (1) N.C. auxiliary contacts
- Mount directly to 145 mm contactors with connection links (included)
- Class 10A trip class
- cULus listed, CE





# GH15 Series Adjustable Overload Relay Features

## RTD32 for 45 mm Contactors

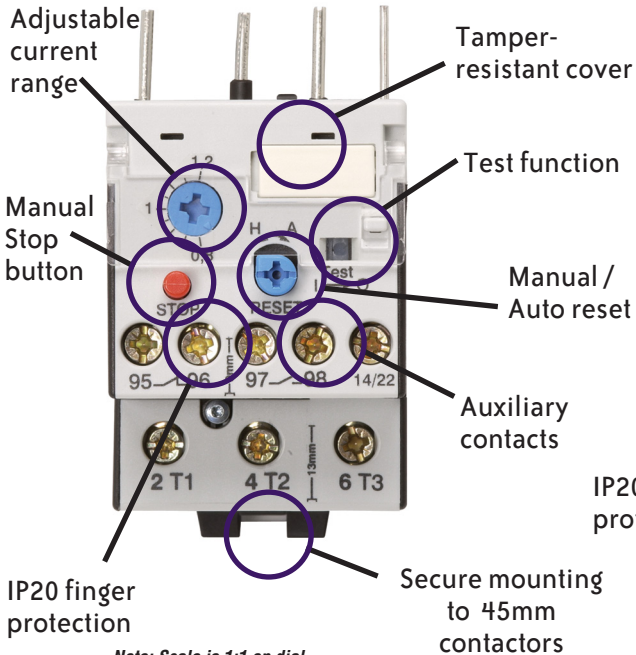

## RTD180 for 79 mm and 110 mm Contactors

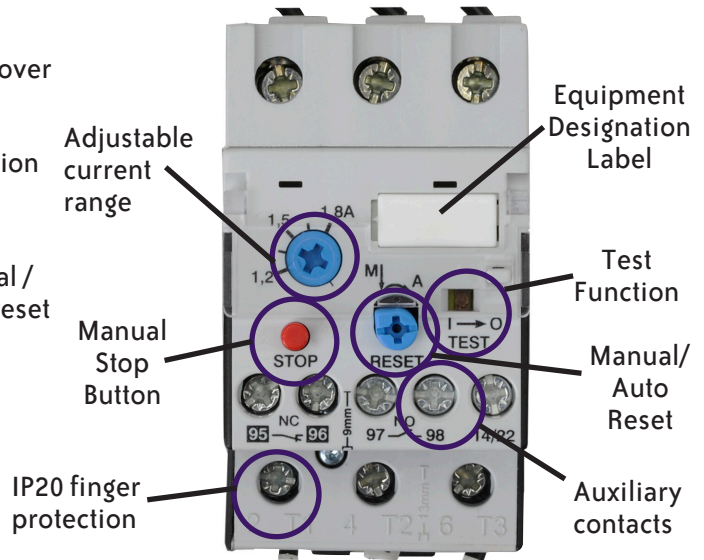

Note: The secondary current for the dial adjustment of the relay is 100x the dial current. For example, for a rated load current of 120A, the relay setting should be 1.2A.

## RTD65 for 60 mm Contactors

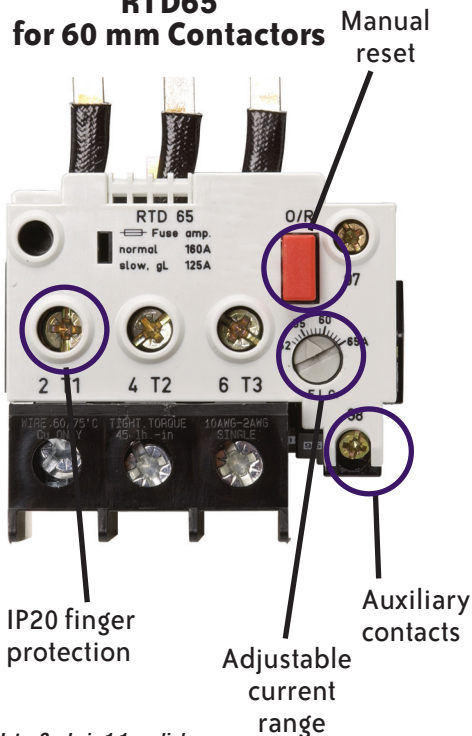

## RTD320 for 145 mm Contactors

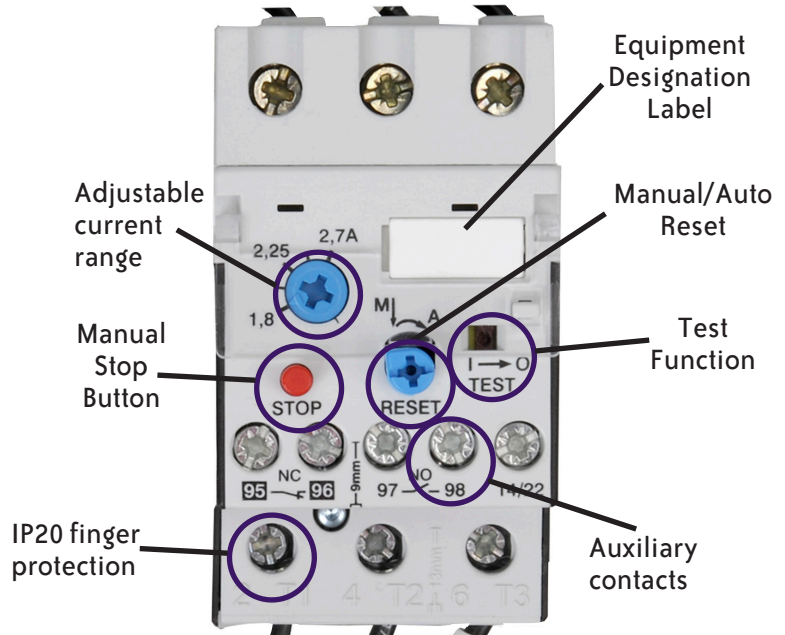

Note: The secondary current for the dial adjustment of the relay is 80x the dial current. For example, for a rated load current of 216A, the relay setting should be 2.7A.

# GH15 Series Overload Relay Selection Guide

- Step 1 Determine the motor FLA and service factor listed on the motor name plate. Next, calculate the size overload protection required based on 2005 NEC 430.32. Select your motor's FLA (Full Load Amperage) from Column A. Tripping current occurs at 125% of FLA in column A.
- Step 2 Follow across to Column B to find your contactor size. Check the maximum amperage rating for that contactor. Ranges overlap and you may have to go to the next larger size.
- Step 3 After selecting your contactor, follow across to Column C to find your overload relay model number.
- Step 4 Order the contactor and overload relay, any desired auxiliary contacts, then assemble and install your motor starter.

Motor Contactor and Overload Relay Selection Guide (When Motor FLA is Known)				
A	B	C	Price	IEC Contactor Frame Size
Current Range Motor FLA	Contactor Model	Overload Relay		
0.4 to 0.6A	GH15BN up to maximum FLA of 9A	<b>RTD32-60</b>	\$62.25	45 mm
0.6 to 0.9A		<b>RTD32-90</b>	\$62.25	
0.8 to 1.2A		<b>RTD32-120</b>	\$62.25	
1.2 to 1.8A		<b>RTD32-180</b>	\$62.25	
1.8 to 2.7A		<b>RTD32-270</b>	\$62.25	
2.7 to 4.0A		<b>RTD32-400</b>	\$62.25	
4.0 to 6.0A		<b>RTD32-600</b>	\$62.25	
6.0 to 9.0A		<b>RTD32-900</b>	\$62.25	
8.0 to 11.0A	GH15CN up to 12A FLA	<b>RTD32-1100</b>	\$62.25	
10.0 to 14.0A		<b>RTD32-1400</b>	\$67.25	
10.0 to 14.0A	GH15DN up to 16A FLA	<b>RTD32-1400</b>	\$67.25	
13.0 to 18.0A		<b>RTD32-1800</b>	\$67.25	
13.0 to 18.0A	GH15ET up to 25A FLA	<b>RTD32-1800</b>	\$67.25	
17.0 to 24.0A		<b>RTD32-2400</b>	\$67.25	
22.0 to 32.0A		<b>RTD32-3200</b>	\$79.50	
22.0 to 32.0A	GH15FT up to 32A FLA	<b>RTD32-3200</b>	\$79.50	
20.0 to 28.0A	GH15GT up to 40A FLA	<b>RTD65-2800</b>	\$116.25	60 mm
28.0 to 42.0A		<b>RTD65-4200</b>	\$116.25	
28.0 to 42.0A	GH15HT up to 50A FLA	<b>RTD65-4200</b>	\$116.25	
40.0 to 52.0A		<b>RTD65-5200</b>	\$144.75	
40.0 to 52.0A	GH15JT up to 63A FLA	<b>RTD65-5200</b>	\$144.75	
52.0 to 65.0A		<b>RTD65-6500</b>	\$144.75	
60.0 to 90.0A	GH15KT up to 80A FLA	<b>RTD180-9000</b>	\$203.00	79 mm
60.0 to 90.0A	GH15LT up to 95A FLA	<b>RTD180-9000</b>	\$203.00	
80.0 to 120.0A	GH15MT up to 110A FLA	<b>RTD180-12000</b>	\$257.25	110 mm
120.0 to 180.0A	GH15NT up to 150A FLA	<b>RTD180-18000</b>	\$277.50	
120.0 to 180.0A	GH15PT up to 175A FLA	<b>RTD180-18000</b>	\$277.50	
144.0 to 216.0A	GH15RT up to 210A FLA	<b>RTD320-21600</b>	\$321.25	
144.0 to 216.0A	GH15ST up to 260A FLA	<b>RTD320-21600</b>	\$321.25	145 mm
216.0 to 320.0A		<b>RTD320-32000</b>	\$321.25	
144.0 to 216.0A	GH15TT up to 315A FLA	<b>RTD320-21600</b>	\$321.25	
216.0 to 320.0A		<b>RTD320-32000</b>	\$321.25	

# GH15 Series Contactors Overload Technical Characteristics

## Typical Trip Curves

### 45 and 60 mm Overloads

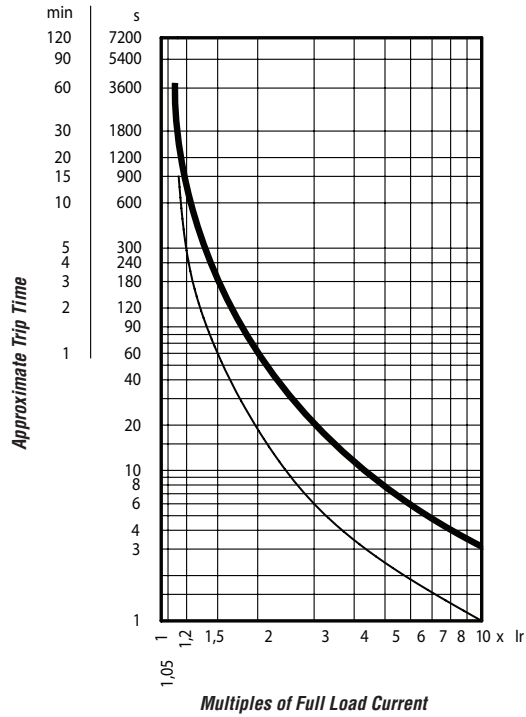

*Note: Curves show tripping time (average value) versus multiples of setting current I<sub>r</sub>.*

*Tripping starting from cold*  
 *Tripping starting from hot*

### 79 mm, 110 mm, and 145 mm Overloads

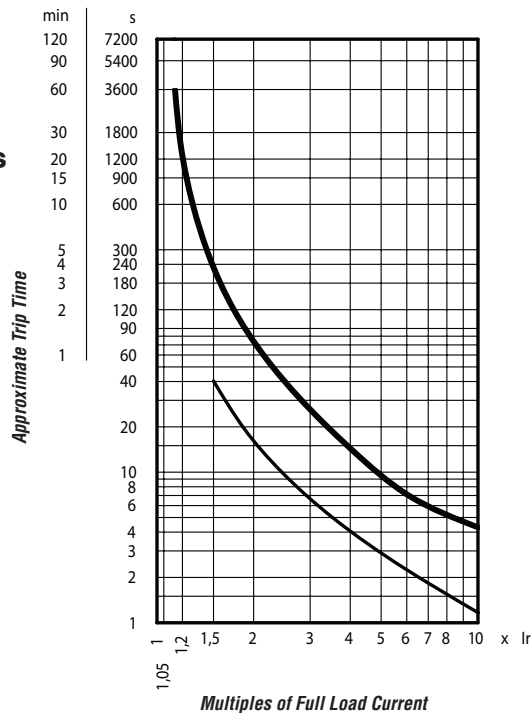

# GH15 Series Contactors Overload Technical Characteristics

Thermal Overload Relays Specifications					
	RTD32	RTD65	RTD180	RTD180-18000	RTD320
<b>Storage temperature</b>	-40 to +70°C (-40°F to 158°F)				
<b>Operating temperature</b>	-25 to +55°C (-13°F to 131°F)				
<b>Tripping class IEC 60947-4-1</b>	10A				
<b>Phase loss sensitive</b>	Yes				
<b>Connection to contactor</b>	Built-in links		Pass through wire	Links for direct	Links for direct
<b>Frequency limits</b>	0-400 Hz		50-60 Hz		
<b>Power dissipation per phase</b>	2.3 Watts	3.7 Watts (52-65 A) setting range: 4.5 W	3 Watts		5 Watts
<b>Short circuit current rating 600V</b>	5kA rms				
<b>Aux contacts wire range</b>	14-10 AWG				
<b>Aux contacts tightening torque</b>	8.1 lb-in				

Contact Rating Code Designation	Thermal Continuous Current (Amps)	Overload Aux Contact Ratings			
		Maximum Current (Amps)			
		120 Volt	240 Volt	480 Volt	600 Volt
		<i>Make / Break</i>	<i>Make / Break</i>	<i>Make / Break</i>	<i>Make / Break</i>
95-96 (NC) B600	5	30 / 3	15 / 1.5	7.5 / 0.75	6 / 0.6
97-98 (NO) C600	2.5	15 / 1.5	7.5 / 0.75	3.75 / 0.375	3 / 0.3

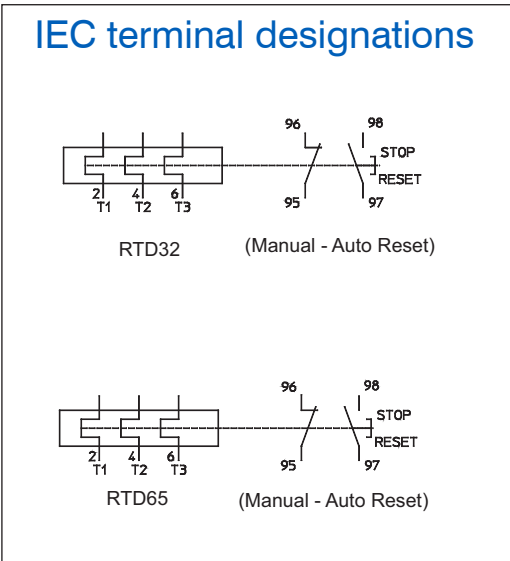

## Wiring Diagrams

### RTD32 / RTD65

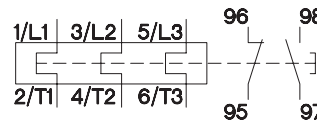

### RTD180 / RTD320

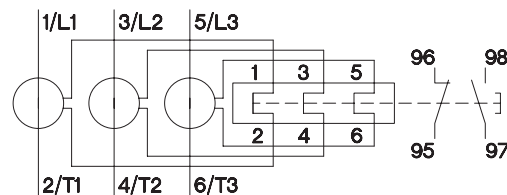

# GH15 Series Overload Relay Dimensions

## 45 mm contactor and overload dimensions

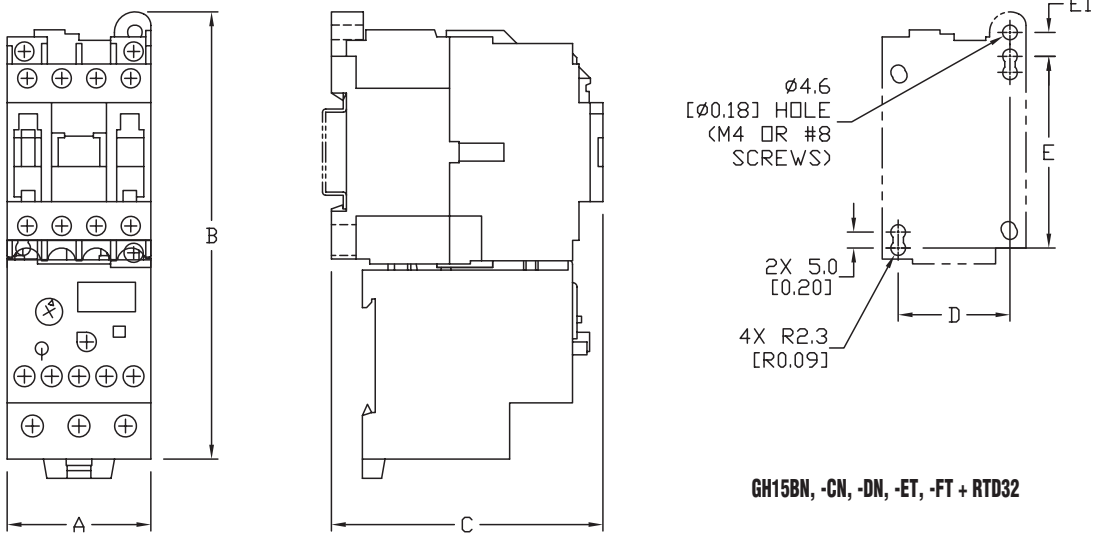

Overload Dimensions mm [inches]													
Contactor Model	Overload Model	Width	Height		Depth	D	E	E1	F	G	H	I	
		A	B	B1	B2								C
GH15BN	RTD32	45.0 [1.77]	146.0 [5.75]	-	-	85.0 [3.35]	35.0 [1.38]	60.0 [2.36]	7.5 [0.30]	-	-	-	
GH15CN													
GH15DN													
GH15ET													
GH15FT													
GH15GT	RTD65	68.5 [2.70]	169.0 [6.65]	-	-	109.0 [4.29]	50.0 [1.97]	100.0 [3.94]	-	-	-	-	
GH15HT													
GH15JT													
GH15KT	RTD180	128.0 [5.04]	contactor and overloads do not have a link connector	137.0 [5.39]	81.0 [3.19]	130.0 [5.12]	70.0 [2.76]	100.0 [3.94]	-	-	68.0 [2.68]	40.0 [1.57]	-
GH15LT				162.0 [6.38]	81.0 [3.19]								
GH15MT				162.0 [6.38]	81.0 [3.19]								
GH15NT	RTD180-18000	128.0 [5.04]	290.0 [11.42]	-	-	145.0 [5.71]	100.0 [3.94]	130.0 [5.12]	-	42.5 [1.67]	68.0 [2.68]	40.0 [1.57]	-
GH15PT													
GH15RT	RTD320	145.0 [5.71]	361.0 [14.21]	-	-	208.0 [8.19]	120.0 [4.72]	160.0 [6.30]	-	80.0 [3.15]	68.0 [2.68]	40.0 [1.57]	96.0 [3.78]
GH15ST													
GH15TT													
GH15TT													



# GH15 Series Overload Relay Dimensions

## 60 mm contactor and overload dimensions

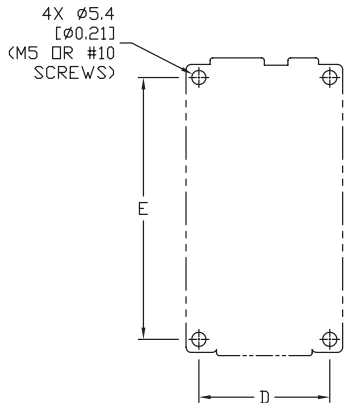
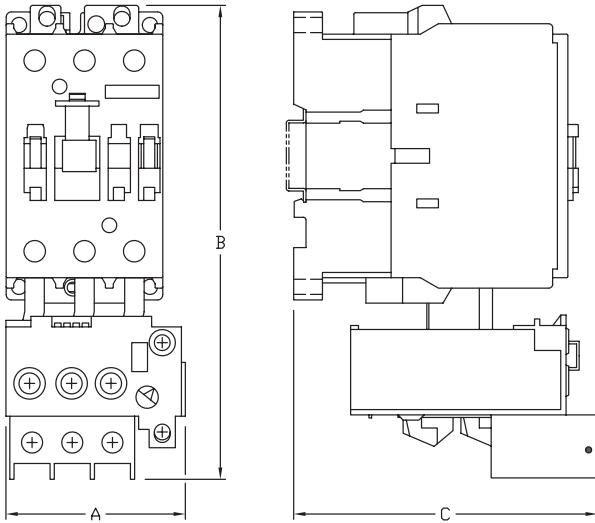

GH15GT, -HT, -JT + RTD65

## 79 mm contactor and overload dimensions

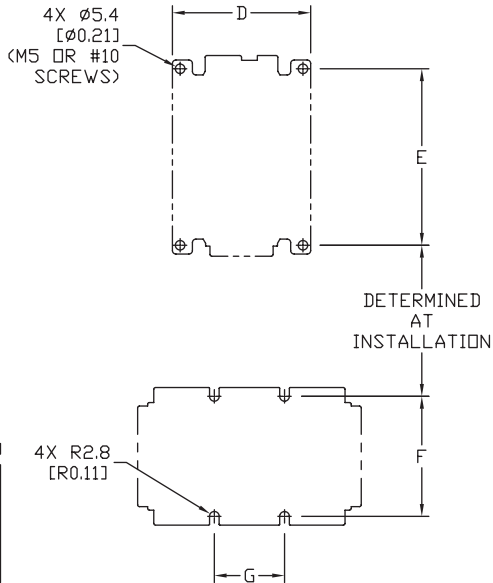
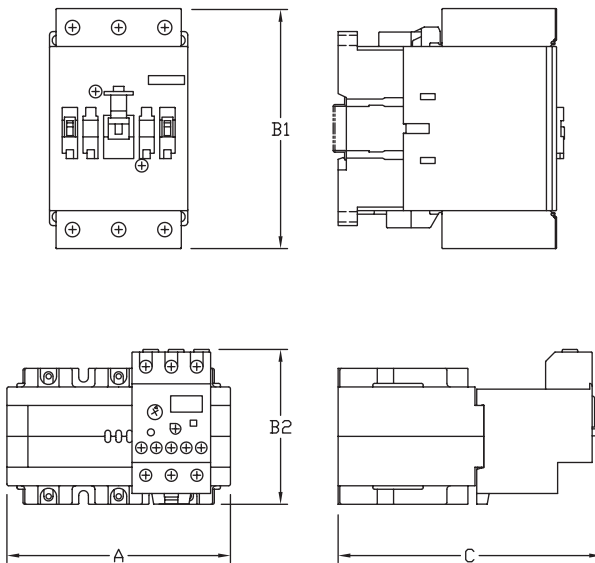

GH15KT, -LT, -MT + RTD180

Note: See our website [www.automationdirect.com](http://www.automationdirect.com) for complete engineering drawings

# GH15 Series Overload Relay Dimensions

## 110 mm contactor and overload dimensions

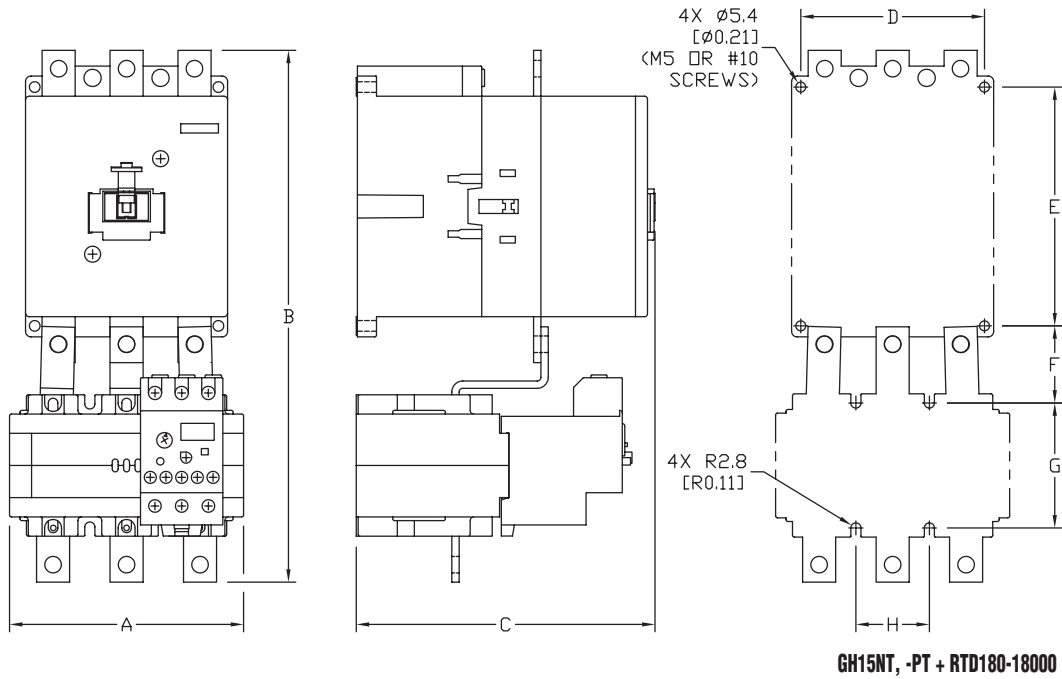

## 145 mm contactor and overload dimensions

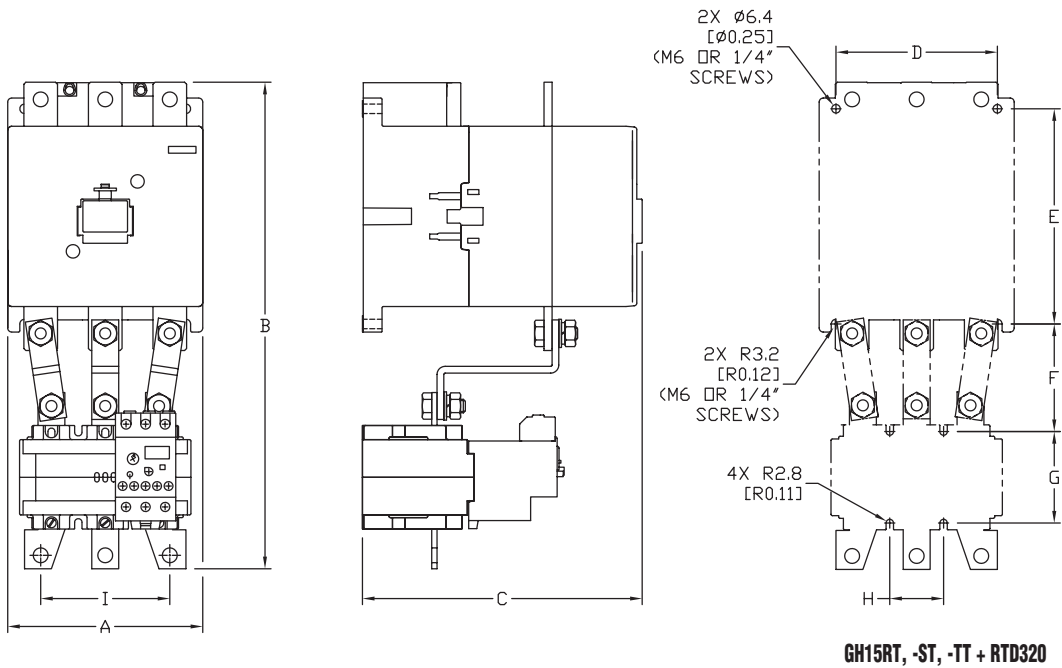

Note: See our website [www.automationdirect.com](http://www.automationdirect.com) for complete engineering drawings