

ENG

User guide

3500 Series

Process Controllers



invensys
EUROTHERM

3508 and 3504 Process Controllers

Contents

1.	CHAPTER 1 WELCOME	6
1.1	What Instrument Do I Have?	6
1.1.1	Contents of Package.....	7
1.2	3504 and 3508 Ordering Code	9
1.3	Configuration Code (Quick Start Code).....	11
2.	CHAPTER 2 INSTALLATION	15
2.1.1	Dimensions.....	15
2.2	Panel Cut-out.....	16
2.2.1	Recommended Minimum Spacing.....	16
2.3	Removing and Replacing the Controller.....	16
2.4	Electrical Connections.....	17
2.5	Wire Sizes	18
2.6	Standard Connections.....	18
2.6.1	PV Input (Measuring Input)	18
2.6.2	Digital I/O	20
2.6.3	Digital (Logic) Outputs	20
2.6.4	Digital (Logic) Outputs used to power a remote 2 wire transmitter.....	21
2.6.5	Digital (Logic) Outputs used to power a remote 3 wire transmitter.....	21
2.6.6	Digital (Logic) Outputs used to power a remote 4 wire transmitter.....	21
2.6.7	Relay Output.....	22
2.6.8	Power Supply Connections.....	23
2.7	Plug in I/O Module Connections.....	24
2.7.1	Relay (2 pin) and Dual Relay Module.....	24
2.7.2	Change Over Relay.....	25
2.7.3	Triple Logic and Isolated Single Logic Output	25

2.7.4	Triac and Dual Triac	25
2.7.5	DC Control	26
2.7.6	DC Retransmission	26
2.7.7	Dual DC Output.....	26
2.7.8	High Resolution DC Retransmission & Transmitter Power Supply	27
2.7.9	Triple Logic Input.....	27
2.7.10	Triple Contact Input	27
2.7.11	24V Transmitter Supply.....	28
2.7.12	Potentiometer input.....	28
2.7.13	Transducer Power Supply.....	29
2.7.14	Analogue Input (T/C, RTD, V, mA, mV).....	30
2.7.15	Analogue Input (Zirconia Probe).....	31
2.7.16	Zirconia Probe Construction.....	31
2.7.17	Zirconia Probe Screening Connections.....	31
2.8	Digital Communications Connections.....	32
2.8.1	Modbus Slave (H or J Module) or ElBisynch.....	32
2.8.2	DeviceNet Wiring	34
2.8.3	Example DeviceNet Wiring Diagram.....	35
2.8.4	Profibus	36
2.8.5	Example Profibus Wiring.....	36
2.8.6	Ethernet (Modbus TCP)	37
2.8.7	I/O Expander.....	38
2.8.8	IO Expander Connections.....	39
2.8.9	Example Wiring Diagram.....	40
2.8.10	Snubbers.....	41
3.	CHAPTER 3: GETTING STARTED	42
3.1	Quick Start - New Controller (Unconfigured).....	42
3.1.1	To Configure Parameters in Quick Start Mode.....	43
3.1.2	Quick Start Parameters.....	44
3.2	To Re-enter Quick Start Mode.....	51

3.2.1	Power up After a Quick Start Configuration.....	51
3.2.2	Power up After A Full Configuration	51
3.3	Normal Operation	52
3.3.1	Beacon Display and Description	53
3.4	The Operator Buttons	54
3.4.1	Shortcut Key Presses.....	55
3.5	To Set The Required Temperature (Setpoint).....	56
3.6	To Select Manual Operation.....	57
3.7	Alarm Indication	58
3.7.1	To Acknowledge an Alarm	58
3.7.2	Sensor Break Indication	59
3.8	Summary Pages.....	60
3.8.1	Navigation of Summary Pages.....	60
3.8.2	How to Edit Parameters	61
3.8.3	Access Level 2	61
3.8.4	Loop Summary.....	62
3.8.5	Program Status Summary	62
3.8.6	Program Edit Summary.....	67
3.8.7	To Create or Edit a Program.....	67
3.8.8	Alarm Summary.....	73
3.8.9	Alarm Settings Summary.....	73
3.8.10	Control Summary.....	74
3.8.11	Transducer Summary.....	76
4.	CHAPTER 4 SAFETY AND EMC INFORMATION	77
4.1	GENERAL	77
4.1.1	Safety	77
4.1.2	Electromagnetic compatibility.....	77
4.1.3	Unpacking and storage.....	78
4.2	Service and repair.....	78
4.2.1	<i>Caution:</i> Charged capacitors.....	78

4.2.2	Electrostatic discharge precautions	78
4.2.3	Cleaning	78
4.3	Installation Safety Requirements	79
4.3.1	Safety Symbols	79
4.3.2	Personnel	79
4.3.3	Enclosure of live parts	79
4.3.4	<i>Caution:</i> Live sensors	79
4.3.5	Wiring	79
4.3.6	Power Isolation	80
4.3.7	Overcurrent protection	80
4.3.8	Voltage rating	80
4.3.9	Conductive pollution	80
4.3.10	Installation Category II	81
4.3.11	Grounding of the Temperature Sensor Shield	81
4.3.12	Over-Temperature Protection	81
4.4	Installation Requirements for EMC	82
4.4.1	Routing of wires	82
5.	CHAPTER 5 TECHNICAL SPECIFICATION	83
5.1	Control Options	83
5.2	Display	83
5.3	Standard Digital I/O	84
5.4	All Analogue and PV Inputs	84
5.5	PV Input	85
5.6	Analogue Input Module	87
5.7	Digital Input Modules	88
5.8	Digital Output Modules	88
5.9	Analogue Output Modules	88
5.10	Transmitter PSU	88
5.11	Transducer PSU	88
5.12	Potentiometer Input	89

5.13	Digital communications	89
5.14	Master communications	89
5.15	Alarms	89
5.16	Setpoint programmer.....	89
5.17	I/O Expander	90
5.18	Advanced functions	90
5.19	General specification	91
6.	RESTRICTION OF HAZARDOUS SUBSTANCES.....	92

Issue status of this manual

Issue 9 adds High Resolution Retransmission and Transmitter Power Supply module (order code HR).

3508 and 3504 Process Controllers

1. Chapter 1 Welcome

1.1 What Instrument Do I Have?

Thank you for choosing this Controller.

The 3508 controller is supplied in the standard 1/8 DIN size (48 x 96mm front panel). The 3504 controller is supplied in the standard ¼ DIN size (96 x 96mm front panel). They are intended for permanent installation, for indoor use only, in an electrical panel which encloses the rear housing, terminals and wiring on the back.



3508 Controller



3504 Controller

The functionality of controller depends on the features which have been ordered, see order code section 1.2. Examples are:-

Programmer. A programmer varies the rate of change of setpoint allowing a profile to be set up.

Plug in modules. These provide customised input/output to plant devices.

The functionality of the controller also depends on how it has been configured. When it is first supplied the controller will enter a Quick Configuration mode which allows a basic set of features to be set up, see section 3.1.

This User Guide describes installation and operation 'out of the box'.

Further detailed configuration may be achieved either by using iTools configuration package or entering deeper levels of access. An Engineering Handbook, Part no. HA027988, provides a detailed description together with an explanation of terminology and may be ordered or downloaded from www.eurotherm.com.

1.1.1 Contents of Package

When unpacking your controller please check that the following items have been included.

3508 or 3504 Controller Mounted in its Sleeve

The 3504 contains up to six plug-in hardware modules; the 3508 has up to three. Additionally digital communications modules can be fitted in two positions.

The modules provide an interface to a wide range of plant devices and those fitted are identified by an ordering code printed on a label fixed to the side of the instrument. Check this against the description of the code given in section 1.2 to ensure that you have the correct modules for your application. This code also defines the basic functionality of the instrument which may be:-

- Controller only
- Programmer and controller
- Control type – Standard PID, valve positioner
- Digital communications type
- Options

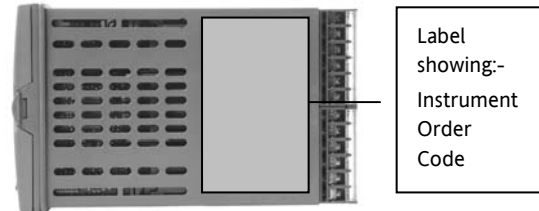

Panel Retaining Clips

Two clips are required to secure the instrument sleeve in the panel. These are supplied fitted to the sleeve.

Accessories Pack

For each input a 2.49Ω resistor is supplied for mA measurement. This will need to be fitted across the respective input terminals

This User Guide

Issue 8 of this guide applies to instrument software versions, V2.30+, and explains:-

- How to install the controller
- Physical wiring to the plant devices
- First switch on - 'out of the box'.
- Principle of operation using the front panel buttons
- Introduction to configuration through iTools PC software
- Ethernet adaptor if Ethernet communications has been ordered

Accessories

The following accessories may be ordered:-

Engineering Manual This may also be downloaded from www.eurotherm.co.uk	HA027988
2.49Ω Precision resistor	SUB35/ACCESS/249R.1
Configuration IR Clip	ITools/None/30000IR
Configuration Clip	ITools/None/30000CK
10In,10Out IO Expander	2000IO/VL/10LR/10LR
20In,20Out IO Expander	2000IO/VL/20LR/20LR

1.2 3504 and 3508 Ordering Code

The controller may have been ordered in accordance with the hardware code listed below. Additionally, it may have been ordered by quoting the 'Quick Code' listed in section 1.3. If ordered to the quick code the controller will be configured in the factory. If it is not ordered using the quick code then it will be necessary to configure the controller when it is first switched on. This is described in Chapter 3.

Hardware/Options Coding

Model Number	Function	Supply Voltage	Number of Loops	Application	Programs	Recipes	Toolkits	Fascia

Model Number	
3504	3504 Standard
3508	3508 Standard

Supply Voltage	
VH	100-240Vac
VL	20-29Vac/dc

Programs	
X	No programs
1	1 prog 20 segments
10	10 prog 500 segments
25	25 prog 500 segments
50	50 prog 500 segments

Toolkit Wires	
XXX	30 wires
60	60 wires
120	120 wires
250	250 wires

Function	
CC	Standard
F	Profibus

Loops	
1	One loop
2	Two loops

Recipes	
X	No recipe
1	1 recipe
4	4 recipes
8	8 recipes

Fascia	
G	Eurotherm green
S	Silver

Application	
XX	Standard
ZC	Zirconia
VP	Dual Valve Position (1)

(1) Provides Valve Position option in Heat/Cool applications. Single channel VP included as standard.

Example (order code)

3504/CC/VH/2/XX/50/X/S/R/2/D4/AM/XX/XX/XX/A2/XX/XX/ENG/ENG/XXXXX/XXXXX

This code describes a two loop 3504 with 50 programs. Additional modules for dual relay, analogue control, analogue input and EIA232 communications. English language and manuals with silver fascia.

Input and Output Modules

I/O Slot 1	I/O Slot 2	I/O Slot 3	I/O Slot 4 (2)	I/O Slot 5 (2)	I/O Slot 6 (2)	H Comms Slot	J Comms Slot	Config Tools	Product Language	Manuals Language	Warranty	Calibration Certificate

IO Slots 1, 2, 3, 4 (2), 5 (2), 6 (2)	
XX	None fitted
R4	Change over relay
R2	2 pin relay
RR	Dual relay
T2	Triac
TT	Dual triac
D4	DC control
DO	Dual DC output 4-20mA OP/24Vdc. Slots 1, 2 and 4 only
AM	Analogue input (not slot 2 or 5)
D6	DC retransmission
TL	Triple logic input
TK	Triple contact input
TP	Triple logic output
VU	Potentiometer input
MS	24Vdc transmitter PSU
G3	Transducer PSU 5 or 10Vdc
HR	High resolution DC retrans & 24Vdc Slots 1, 2 and 4 only
LO	Isolated single logic output

H Comms Slot	
XX	Not Fitted
A2	232 Modbus
Y2	2-wire 485 Modbus
F2	4-wire 485 Modbus
AE	232 EI-Bisynch
YE	2-wire 485 EI-Bisynch
FE	4-wire 485 EI-Bisynch
ET	Ethernet 10base
PB	Profibus (3)
PD	Profibus with D type connector (3)
DN	Devicenet

J Comms Slot	
XX	Not Fitted
A2	232 Modbus
Y2	2-wire 485 Modbus
F2	4-wire 485 Modbus
EX	IO Expander

Config Tools	
XX	None
IT	Standard iTools (CD only)

Product Language	
ENG	English
FRA	French
GER	German
SPA	Spanish
ITA	Italian

Manual Language	
ENG	English
FRA	French
GER	German
SPA	Spanish
ITA	Italian
XXX	None

Warranty	
XXXXX	Standard
WL005	Extended

Calibration Certificate	
XXXXX	None
CERT1	Cert of conformity
CERT2	Factory input calibration per input

- (2). I/O slots 4, 5 and 6 are only available on the 3504
- (3). Only available with the Profibus Controller

1.3 Configuration Code (Quick Start Code)

Loop 1

Config	Loop 1 Units	Loop 1 Function	Loop 1 PV	Loop 1 Range Lo	Loop 1 Range Hi

Config	
STD	Standard config (1)
CFG	Factory configured

Loop 1 units	
C	Centigrade
F	Fahrenheit
%	Percent
H	%RH
P	PSI
B	Bar
M	mBar
X	None

Loop 1 Function	
PX	Single Chan. PID
FX	Single Chan. VP with Feedback
VX	Single Chan. VP without Feedback
NX	Single Chan. On/Off
PP	Dual Chan. PID
PN	Dual Chan. PID/OnOff
FF	Dual Chan. VP with Feedback
VV	Dual Chan. VP without Feedback
PF	Dual Chan. PID/VP with Feedback
PV	Dual Chan. PID/VP without

Loop 1 PV	
X	Unconfigured
J	J Thermocouple
K	K Thermocouple
T	T Thermocouple
L	L Thermocouple
N	N Thermocouple
R	R Thermocouple
S	S Thermocouple
B	B Thermocouple
P	Platinell II
C	C Thermocouple
Z	Pt 100
A	4-20mA Linear
Y	0-20mA Linear
W	0-5Vdc Linear
G	1-5Vdc Linear
V	0-10Vdc Linear
Q	Custom Curve

Loop 1 Range Low	
XXXXX	Enter value with decimal point

Loop 1 Range High	
XXXXX	Enter value with decimal point

1. If standard config is selected an instrument without configuration will be supplied.

Loop 2

Loop 2 Units	Loop 2 Function	Loop 2 PV	Loop 2 Range Lo	Loop 2 Range Hi

Loop 2 Units	
C	Centigrade (2)
F	Fahrenheit (2)
%	Percent
H	%RH
P	PSI
B	Bar
M	mBar
X	None

Loop 2 Function	
XX	Single Loop Only
PX	Single Chan. PID
FX	Single Chan. VP with Feedback
VX	Single Chan. VP without Feedback
NX	Single Chan. On/Off
PP	Dual Chan. PID
PN	Dual Chan. PID/OnOff
FF	Dual Chan. VP with Feedback
VV	Dual Chan. VP without Feedback
PF	Dual Chan. PID/VP with Feedback
PV	Dual Chan. PID/VP without

Loop 2 PV	
X	Unconfigured
J	J Thermocouple
K	K Thermocouple
T	T Thermocouple
L	L Thermocouple
N	N Thermocouple
R	R Thermocouple
S	S Thermocouple
B	B Thermocouple
P	Platinell II
C	C Thermocouple
Z	Pt 100
A	4-20mA Linear
Y	0-20mA Linear
W	0-5Vdc Linear
G	1-5Vdc Linear
V	0-10Vdc Linear
Q	Custom Curve

Loop 2 Range Low	
XXXXX	Enter value with decimal point

Loop 2 Range High	
XXXXX	Enter value with decimal point

(2). If C or F units are selected they must be the same for both loops.
If C or F are not selected for Loop 1 they cannot be selected for Loop 2

Alarms and Input/Outputs

Alarm 1	Alarm 2	Alarm 3	Alarm 4	Logic LA	Logic LB	Relay AA	I/O Slot 1	I/O Slot 2	I/O Slot 3	I/O Slot 4 (3)	I/O Slot 5 (3)	I/O Slot 6 (3)

Alarm 1	
XXX	Unconfigured
1__	Loop 1
2__	Loop 2
_FH	Full scale high
_FL	Full scale low
_DH	Deviation high
_DL	Deviation low
_DB	Deviation band

Alarm 3	
XXX	Unconfigured
1__	Loop 1
2__	Loop 2
_FH	Full scale high
_FL	Full scale low
_DH	Deviation high
_DL	Deviation low
_DB	Deviation band

Logic LA	
XX	Unconfigured
1_	Loop 1
2_	Loop 2
_B	Sensor Break
_M	Manual Select
_H	Control Ch1 OP
_C	Control Ch2 OP
_R	Remote SP
_S	Setpoint 2 Enable
A_	Alarm
_A	Acknowledge All Alarms
_1	Alarm 1 OP
_2	Alarm 2 OP
P_	Programmer
_R	Run
_H	Hold
_A	Reset
_1	Prg Ch1 Event 1
_2	Prg Ch1 Event 2

Logic LB	
XX	Unconfigured
1_	Loop 1
2_	Loop 2
_B	Sensor Break
_M	Manual Select
_H	Ch1 OP
_C	Ch2 OP
_R	Remote SP
_S	Setpoint 2 Enable
A_	Alarm
_A	Acknowledge All Alarms
_1	Alarm 1 OP
_2	Alarm 2 OP
P_	Programmer
_R	Run
_H	Hold
_A	Reset
_1	Prg Event 1
_2	Prg Event 2

Relay AA	
XX	Unconfigured
1_	Loop 1
2_	Loop 2
_H	Control Ch1 OP
_C	Control Ch2 OP
_B	Sensor Break
SB	Sensor Break (any loop)
A_	Alarm
_A	Any Alarm Active
_N	New Alarm Active
_1	Alarm 1 OP
_2	Alarm 2 OP
P_	Programmer
_1	Prg Event 1
_2	Prg Event 2

(3): I/O slots 4, 5 and 6 are only available on the 3504.

Slot Functions 1 – 6 CH1 = Heat, CH2 = Cool			
XXX	Unconfigured	HHX	Ch1 OP for loops 1 & 2
1__	Loop 1	CCX	Ch2 OP for loops 1 & 2
2__	Loop 2	SBR	Sensor Break both loops
Changeover Relay		Dual Triac	
_HX	Control Ch1 OP	_HC	Ch1 OP & Ch2
_CX	Control Ch2 OP	_VT	VP Ch1
_BX	Sensor Break	_VR	VP Ch2
2-Pin Relay		P12	Prg Ch1 Event 1 & 2
_HX	Control Ch1 OP	P34	Prg Ch1 Event 3 & 3
_CX	Control Ch2 OP	P56	Prg Ch1 Event 5 & 6
_BX	Sensor Break	P78	Prg Ch1 Event 7 & 8
Single Logic		A12	Alarm 1 & 2 OP
_HX	Control Ch1 OP	A34	Alarm 3 & 4 OP
_CX	Control Ch2 OP	HHX	Ch1 OP for loops 1 & 2
Single Triac		CCX	Ch2 OP for loops 1 & 2
_HX	Control Ch1 OP	DC Control	
_CX	Control Ch2 OP	_H_	Ch1 OP
Dual Relay		_C_	Ch2 OP
_HC	Ch1 OP & Ch2	DC Retransmission *	
_VT	VP Ch1	_T_	PV Retransmission
_VR	VP Ch2	_S_	SP Retransmission
P12	Prg Event 1 & 2	Analogue Input *	
P34	Prg Event 3 & 3	2PV	Loop 2 PV
P56	Prg Event 5 & 6	_R_	Remote SP
P78	Prg Event 7 & 8	Potentiometer Input *	
A12	Alarm 1 & 2 OP	_RS	Remote SP
A34	Alarm 3 & 4 OP	_VF	VP Feedback Ch1
		_VG	VP Feedback Ch2
		Triple Logic Input	
		---	Select function below for each channel
		X	Unconfigured
		M	Loop 1 Manual
		N	Loop 2 Manual
		Q	Loop 1 Remote SP
		V	Loop 2 Remote SP
		S	Loop 1 Setpoint 2
		T	Loop 2 Setpoint 2
		E	Acknowledge All Alarms
		P	Program Run
		R	Program Reset
		H	Program Hold
		* For range, select from Table A below	
		Table 1	
		A	4-20mA Linear
		Y	0-20mA Linear
		W	0-5Vdc Linear
		G	1-5Vdc Linear
		V	0-10Vdc Linear
		Triple Logic OP	
---	Select function below for each channel	X	Unconfigured
X	Unconfigured	F	Loop 1 Ch1 OP
F	Loop 1 Ch1 OP	G	Loop 1 Ch2 OP
G	Loop 1 Ch2 OP	K	Loop 2 Ch1 OP
K	Loop 2 Ch1 OP	L	Loop 2 Control Ch2 OP
L	Loop 2 Control Ch2 OP	A	Alarm 1 OP
A	Alarm 1 OP	B	Alarm 2 OP
B	Alarm 2 OP	C	Alarm 3 OP
C	Alarm 3 OP	D	Alarm 4 OP
D	Alarm 4 OP	1	Program Event 1
1	Program Event 1	2	Program Event 2
2	Program Event 2	3	Program Event 3
3	Program Event 3	4	Program Event 4
4	Program Event 4	5	Program Event 5
5	Program Event 5	6	Program Event 6
6	Program Event 6	7	Program Event 7
7	Program Event 7	8	Program Event 8
8	Program Event 8		

2. Chapter 2 Installation

This instrument is intended for permanent installation, for indoor use only, and to be enclosed in an electrical panel.

Select a location where minimum vibrations are present and the ambient temperature is within 0 and 50°C (32 and 122°F).

The instrument can be mounted on a panel up to 15mm thick.

To assure IP65 and NEMA 4 front protection, use a panel with smooth surface texture.

Please read the safety information, at the end of this guide, before proceeding and refer to the EMC Booklet part number HA025464 for further information. This and other relevant manuals may be downloaded from www.eurotherm.com.

2.1.1 Dimensions

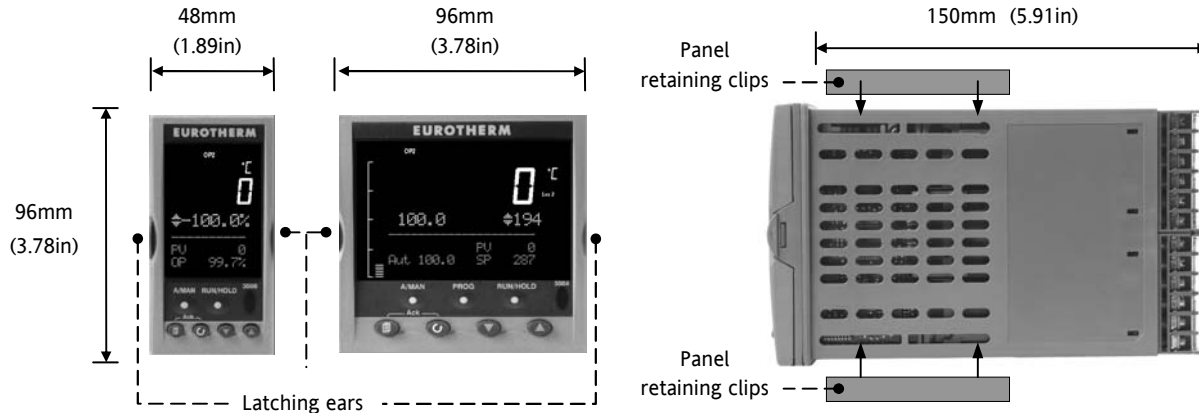

2.2 Panel Cut-out

1. Prepare the panel cut-out to the size shown in the diagram.
2. Insert the controller through the cut-out. The controller may remain in its sleeve when mounting it in the panel.
3. Spring the panel retaining clips into place. Secure the controller in position by holding it level and pushing both retaining clips forward.
4. Peel off the protective cover from the display.

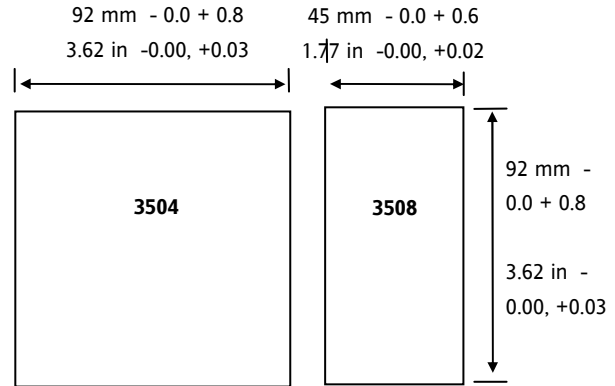

2.2.1 Recommended Minimum Spacing

5. The recommended minimum spacing between controllers is to allow sufficient natural air flow and should not be less than that shown.

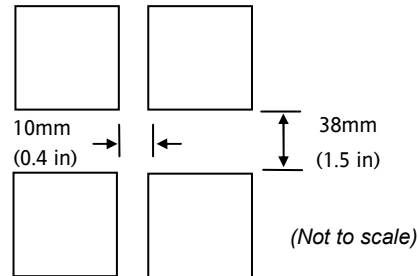

2.3 Removing and Replacing the Controller

The controller can be unplugged from its sleeve by easing the latching ears outwards and pulling it forward out of the sleeve. When plugging it back into its sleeve, ensure that the latching ears click back into place to maintain the IP65 sealing.

2.5 Wire Sizes

The screw terminals accept wire sizes from 0.5 to 1.5 mm (16 to 22AWG). Hinged covers prevent hands or metal making accidental contact with live wires. The rear terminal screws should be tightened to 0.4Nm (3.5lb in).

2.6 Standard Connections

These are connections which are common to all instruments in the range.

2.6.1 PV Input (Measuring Input)

Notes:

1. Do not run input wires together with power cables
2. When shielded cable is used, it should be grounded at one point only
3. Any external components (such as zener barriers, etc) connected between sensor and input terminals may cause errors in measurement due to excessive and/or un-balanced line resistance or possible leakage currents
4. Not isolated from logic I/O A and logic I/O B

2.6.1.1 Thermocouple or Pyrometer Input

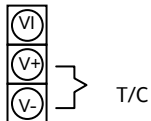

Use the correct type of thermocouple compensating cable, preferably shielded, to extend wiring

2.6.1.2 RTD Input

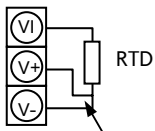

For 2-wire
this is a
local link

The resistance of the three wires must be the same

The line resistance may cause errors if it is greater than 22Ω

Note: the RTD wiring is not the same as 2400 series instruments. It is the same as 26/2700 series

2.6.1.3 Linear Input V, mV and High Impedance V

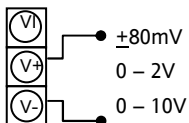

mV range $\pm 40\text{mV}$ or $\pm 80\text{mV}$

High level range 0 – 10V

High Impedance mid level range 0 – 2V. Used for zirconia probe oxygen input.

A line resistance for voltage inputs may cause measurement errors

2.6.1.4 Linear Input mA

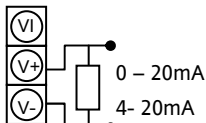

Connect the supplied load resistor equal to 2.49Ω for mA input

The resistor supplied is 1% accuracy 50ppm

A resistor 0.1% accuracy 15ppm resistor can be ordered as a separate item. Part No. SUB35/ACCESS/249R.1

2.6.2 Digital I/O

These terminals may be configured as logic inputs, contact inputs or logic outputs in any combination. It is possible to have one input and one output on either channel.



The Digital IO is not isolated from the PV input

2.6.2.1 Logic Inputs

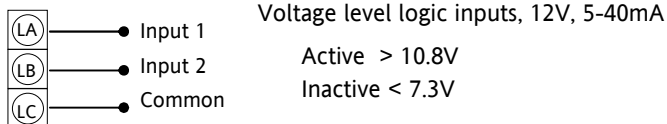

2.6.2.2 Contact Closure Inputs

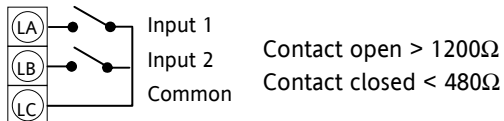

2.6.3 Digital (Logic) Outputs

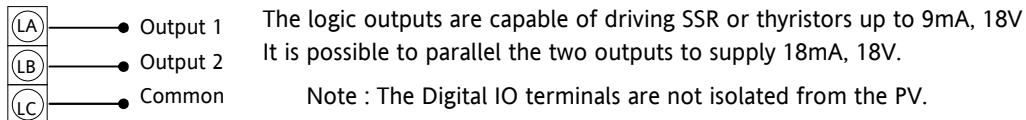

The fixed digital logic outputs may be used to power remote 2 wire transmitters. The fixed digital I/O are, however, not isolated from the PV input circuit, so this does not allow the use of 3 or 4 wire transmitters. An isolated module must be used for the 3 and 4 wire types.

2.6.4 Digital (Logic) Outputs used to power a remote 2 wire transmitter.

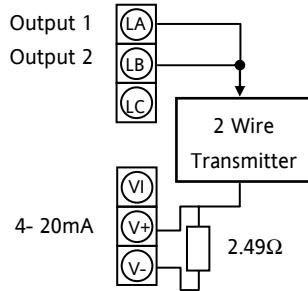

The parallel logic outputs supply >20mA, 18V.

Note : The Digital IO terminals are not isolated from the PV.

Connect the supplied load resistor equal to 2.49Ω for mA input

2.6.5 Digital (Logic) Outputs used to power a remote 3 wire transmitter.

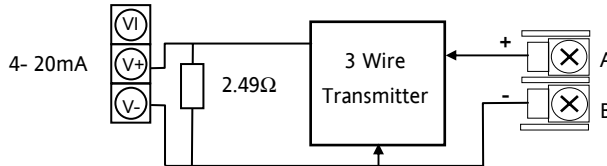

Isolated Transmitter Option
module +24V >20mA

2.6.6 Digital (Logic) Outputs used to power a remote 4 wire transmitter.

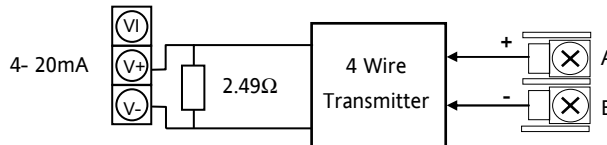

Isolated Transmitter Option
module +24V >20mA

2.6.7 Relay Output

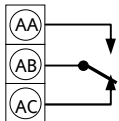

Relay rating, min: 1V, 1mAdc. Max: 264Vac 2A resistive

Relay shown in de-energised state

Isolated output 240Vac CATII

2.6.7.1 General Note About Inductive Loads

High voltage transients may occur when switching inductive loads such as some contactors or solenoid valves.

For this type of load it is recommended that a 'snubber' is connected across the contact of the relay switching the load. The snubber typically consists of a 15nF capacitor connected in series with a 100Ω resistor and will also prolong the life of the relay contacts.



When the relay contact is open and it is connected to a load, the snubber passes a current (typically 0.6mA at 110Vac and 1.2mA at 240Vac). It is the responsibility of the installer to ensure that this current does not hold on the power to an electrical load. If the load is of this type the snubber should not be connected.

See also section 2.8.9 and 2.8.10.

2.6.8 Power Supply Connections

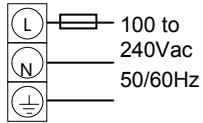

1. Before connecting the instrument to the power line, make sure that the line voltage corresponds to the description on the identification label
2. For supply connections use 16AWG or larger wires rated for at least 75°C
3. Use copper conductors only
4. For 24V the polarity is not important
5. It is the Users responsibility to provide an external fuse or circuit breaker.

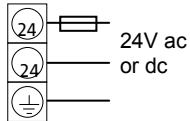

For 24 V ac/dc fuse type T rated 4A 250V

For 100/240Vac fuse type T rated 1A 250V

Safety requirements for permanently connected equipment state:

- a switch or circuit breaker shall be included in the building installation
- it shall be in close proximity to the equipment and within easy reach of the operator
- it shall be marked as the disconnecting device for the equipment

Note: a single switch or circuit breaker can supply more than one instrument

2.7 Plug in I/O Module Connections

Plug in I/O modules can be fitted in three positions in the 3508 and six positions in 3504. The positions are marked Module 1, 2, 3, 4, 5, 6. With the exception of the Analogue Input module, any other module listed in this section, can be fitted in any of these positions. To find out which modules are fitted check the ordering code printed on a label on the side of the instrument. If modules have been added, removed or changed it is recommended that this is recorded on the instrument code label.

The function of the connections varies depending on the type of module fitted in each position and this is shown below. All modules are isolated.

Note: The order code and terminal number is pre-fixed by the module number. For example, Module 1 is connected to terminals 1A, 1B, 1C, 1D; module 2 to 2A, 2B, 2C, 2D, etc.

2.7.1 Relay (2 pin) and Dual Relay Module

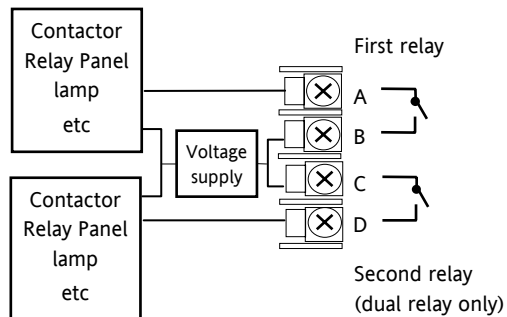

- Hardware Code: R2 and RR
- Relays Rating: 2A, 264Vac max or 1mA, 1V min
- Typical usage: Heating, cooling, alarm, program event, valve raise, valve lower
- Isolated output 240Vac CATII

2.7.2 Change Over Relay

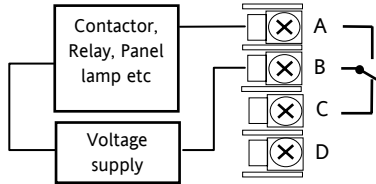

- Hardware Code: R4
- Relay Rating: 2A, 264Vac max or 1mA, 1V min
- Typical usage: Heating, cooling, alarm, program event, valve raise, valve lower.
- Isolated output 240Vac CATII

2.7.3 Triple Logic and Isolated Single Logic Output

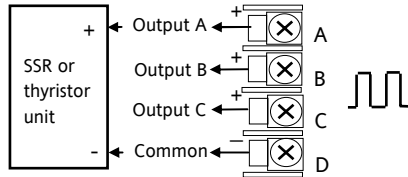

- Hardware Code: TP and LO
- Outputs Rating: (18Vdc at 8mA max.)
- Typical usage: Heating, cooling, program events.
- Isolated output 240Vac CATII
- Single Logic Output connections: D – Common A – Logic Output

2.7.4 Triac and Dual Triac

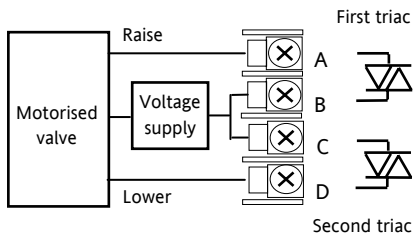

- Hardware Code: T2 and TT
- Combined Output Rating: 0.7A, 30 to 264Vac
- Typical usage: Heating, cooling, valve raise, valve lower.
- Isolated output 240Vac CATII
- Dual relay modules may be used in place of dual triac.
- **The combined current rating for the two triacs must not exceed 0.7A**

2.7.5 DC Control

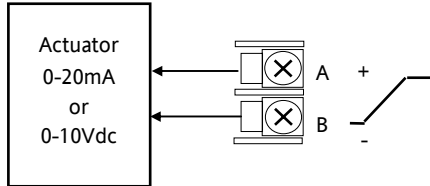

- Hardware Code: D4
- Output Rating: (10Vdc, 20mA max)
- Typical Usage: Heating, cooling e.g. to a 4-20mA process actuator
- Isolated output 240Vac CATII

2.7.6 DC Retransmission

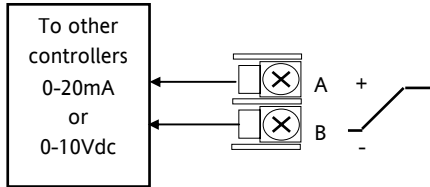

- Hardware Code: D6
- Output Rating: (10Vdc, 20mA max)
- Typical Usage: Logging of PV, SP, output power, etc., (0 to 10Vdc or 0 to 20mA)
- Isolated output 240Vac CATII

2.7.7 Dual DC Output

Slots 1, 2 and 4 only

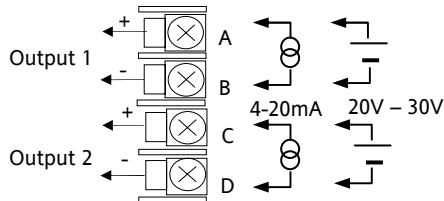

- Hardware Code: DO
- Output Rating: each channel can be 4-20mA or 24Vdc power supply)
- Typical Usage: Control output 12 bit resolution

2.7.8 High Resolution DC Retransmission & Transmitter Power Supply

Slots 1, 2 and 4 only

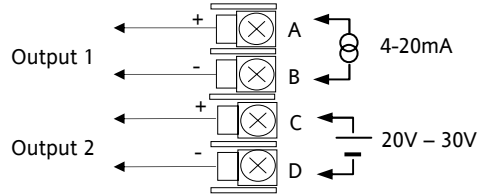

- Hardware Code: HR
- Output Rating: Channel 1 (15 bit 4-20mA). Channel 2 (24Vdc)
- Typical Usage: Retransmission Channel 1. Transmitter power supply Channel 2

2.7.9 Triple Logic Input

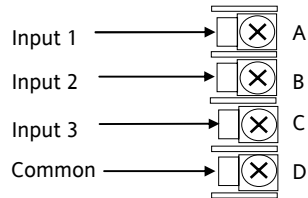

- Hardware Code: TL
- Input Ratings: Logic inputs <5V OFF >10.8V ON Limits: -3V, +30V
- Typical Usage: Events e.g. Program Run, Reset, Hold
- Isolated output 240Vac CATII

2.7.10 Triple Contact Input

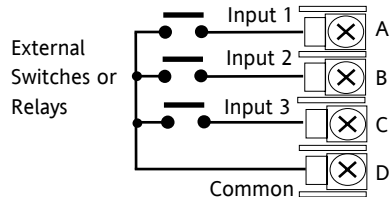

- Hardware Code: TK
- Input Ratings: Logic inputs >28KΩ OFF <100Ω ON
- Typical Usage: Events e.g. Program Run, Reset, Hold
- Isolated output 240Vac CATII

2.7.11 24V Transmitter Supply

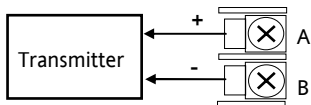

- Hardware Code: MS
- Output Rating: 24Vdc 20mA
- Typical Usage: To power an external transmitter
- Isolated output 240Vac CATII

2.7.12 Potentiometer input

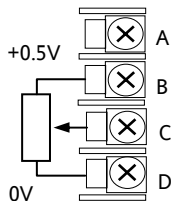

- Hardware Code: VU
- Rating: 100 Ω to 15K Ω
- Typical Usage: Valve position feedback, Remote setpoint
- Isolated output 240Vac CATII

2.7.13 Transducer Power Supply

Transducer with Internal Calibration Resistor

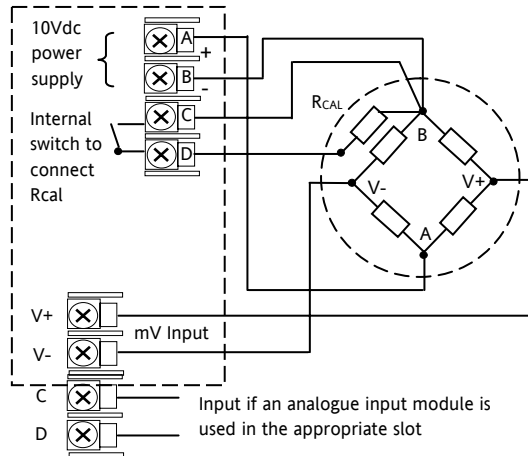

- Hardware Code: G3
- Rating: Configurable 5V or 10Vdc. Minimum load resistance 300Ω
- Typical Usage: Strain Gauge transducer power and measurement
- Isolated output 240Vac CATII

Transducer with External Calibration Resistor

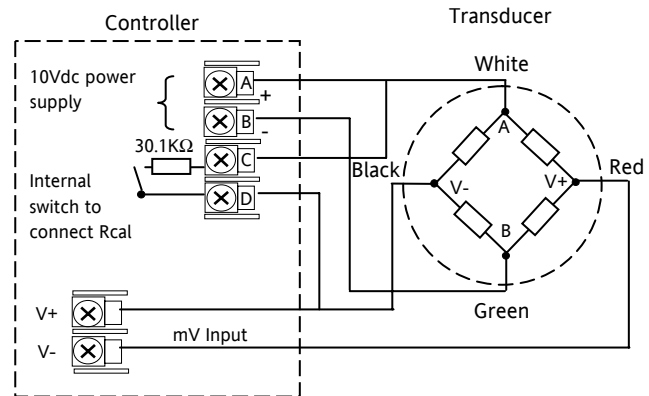

2.7.14 Analogue Input (T/C, RTD, V, mA, mV)

Slots 1, 3, 4 & 6 only

- Hardware Code: AM
- Typical Usage: Second PV input, Remote setpoint
- Isolated 240Vac CATII

Thermocouple

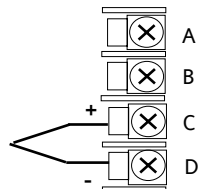

3-wire RTD

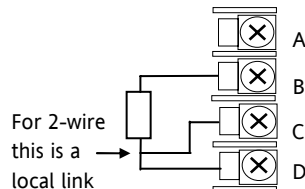

Voltage

-3 to 10V or -1.4 to 2V

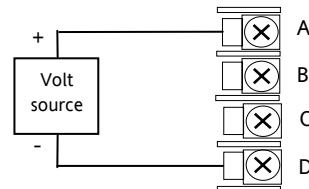

Current

0 to 20mA or (4 to 20mA)

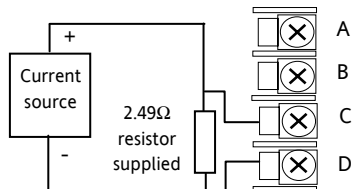

mV

(±40mV or ±80mV)

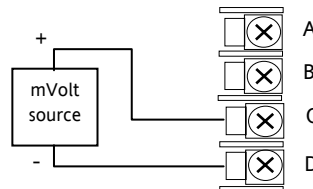

2.7.15 Analogue Input (Zirconia Probe)

- The temperature sensor of the zirconia probe can be connected to the Fixed PV input, terminals V+ and V-, or to an Analogue Input module, terminals C & D. The Volt Source connected to an Analogue Input module, terminals A & D.

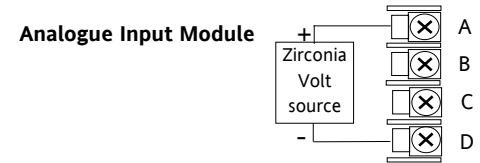
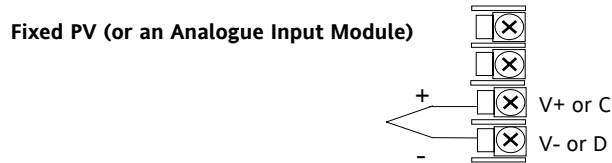

2.7.16 Zirconia Probe Construction

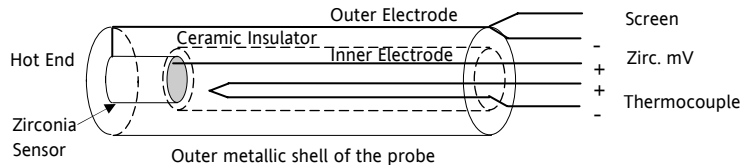

2.7.17 Zirconia Probe Screening Connections

The zirconia sensor wires should be screened and connected to the outer shell of the probe if it is situated in an area of high interference.

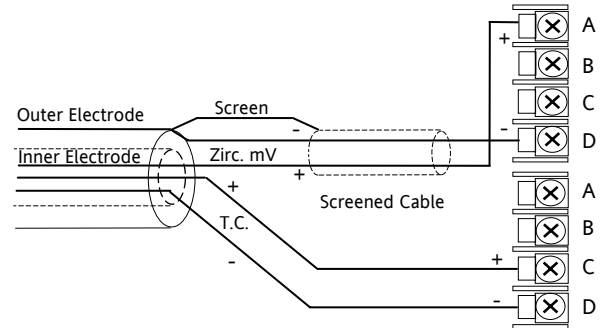

2.8 Digital Communications Connections

Digital Communications modules can be fitted in two positions in both 3508 and 3504 controllers. The connections being available on HA to HF and JA to JF depending on the position in which the module is fitted. The two positions could be used, for example, to communicate with 'iTools' configuration package on one position, and to a PC running a supervisory package on the second position.

Communications protocols may be Modbus, EIBisynch, DeviceNet®, Profibus or Modbus TCP.

Note:- In order to reduce the effects of RF interference the transmission line should be grounded at both ends of the screened cable. However, if such a course is taken care must be taken to ensure that differences in the earth potentials do not allow circulating currents to flow, as these can induce common mode signals in the data lines. Where doubt exists it is recommended that the Screen (shield) be grounded at only one section of the network as shown in all of the following diagrams.

- Digital communications modules isolated 240Vac CATII

2.8.1 Modbus Slave (H or J Module) or EIBisynch

A further description of Modbus and EIBisynch communications is given in 2000 series Communications Handbook, Part No. HA026230, which can be downloaded from www.eurotherm.com.

EIA232 Connections

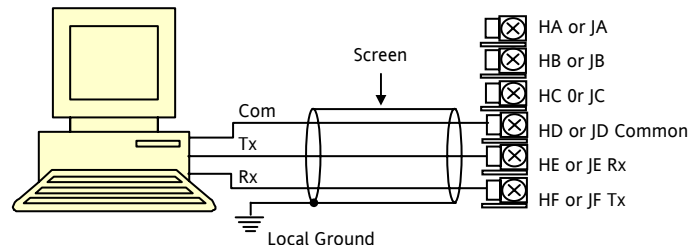

EIA485 2-Wire Connections

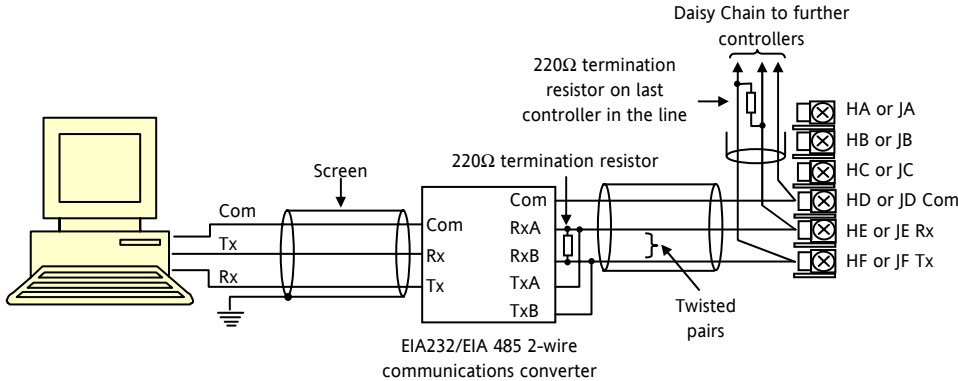

The KD485 communications converter is recommended for interfacing to EIA 485. This unit is also used to buffer an EIA 485 network when it is required to communicate with more than 32 instruments on the same bus, and may also be used to bridge 2-wire EIA485 to 4-wire EIA 422.

EIA422/EIA485 4-Wire Connections

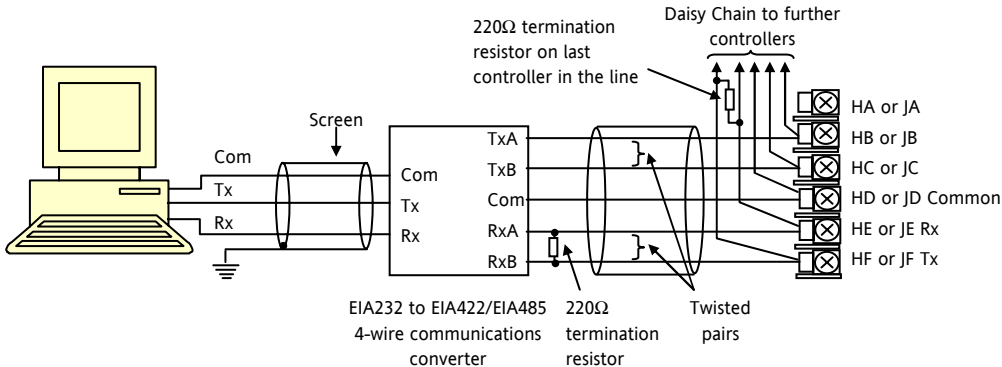

The KD485 communications converter is recommended for: Interfacing 4-wire to 2-wire connections. To buffer an EIA 422/485 network when more than 32 instruments on the same bus are required. To bridge 2-wire EIA 485 to 4-wire EIA 422.

2.8.2 DeviceNet Wiring

It is not within the scope of this manual to describe the DeviceNet standard. For this please refer to the DeviceNet specification which may be found at www.odva.org.

In practice it is envisaged that 3500 series controllers will be added to an existing DeviceNet network. This section, therefore, is designed to provide general guidelines to connect 3500 series controllers to this network. Further information is also available in the DeviceNet Communications Handbook Part No HA027506 which can be downloaded from www.eurotherm.com.

According to the DeviceNet standard two types of cable may be used. These are known as Thick Trunk and Thin Trunk. For long trunk lines it is normal to use Thick trunk cable. For drop lines thin trunk cable is generally more convenient being easier to install. The table below shows the relationship between cable type, length and baud rate.

<i>Network length</i>	<i>Varies with speed. Up to 400m possible with repeaters</i>		
Baud Rate Mb/s	125	250	500
Thick trunk	500m (1,640ft)	200m (656ft)	75m (246ft)
Thin trunk	100m (328ft)	100m (328ft)	100m (328ft)

This table shows standard cable connections.

Controller Terminal	CAN Label	Wire Colour	Description
HA	V+	Red	DeviceNet network power positive terminal. Connect the red wire of the DeviceNet cable here. If the DeviceNet network does not supply the power, connect to the positive terminal of an external 24 Vdc power supply.
HB	CAN_H	White	DeviceNet CAN_H data bus terminal. Connect the white wire of the DeviceNet cable here.
HC	SHIELD	None	Shield/Drain wire connection. Connect the DeviceNet cable shield here. To prevent ground loops, the DeviceNet network should be grounded in only one location.
HD	CAN_L	Blue	DeviceNet CAN_L data bus terminal. Connect the blue wire of the DeviceNet cable here.
HE	V-	Black	DeviceNet network power negative terminal. Connect the black wire of the DeviceNet cable here. If the DeviceNet network does not supply the power, connect to the negative terminal of an external 24 Vdc power supply.
HF			Connect to instrument earth

2.8.3 Example DeviceNet Wiring Diagram

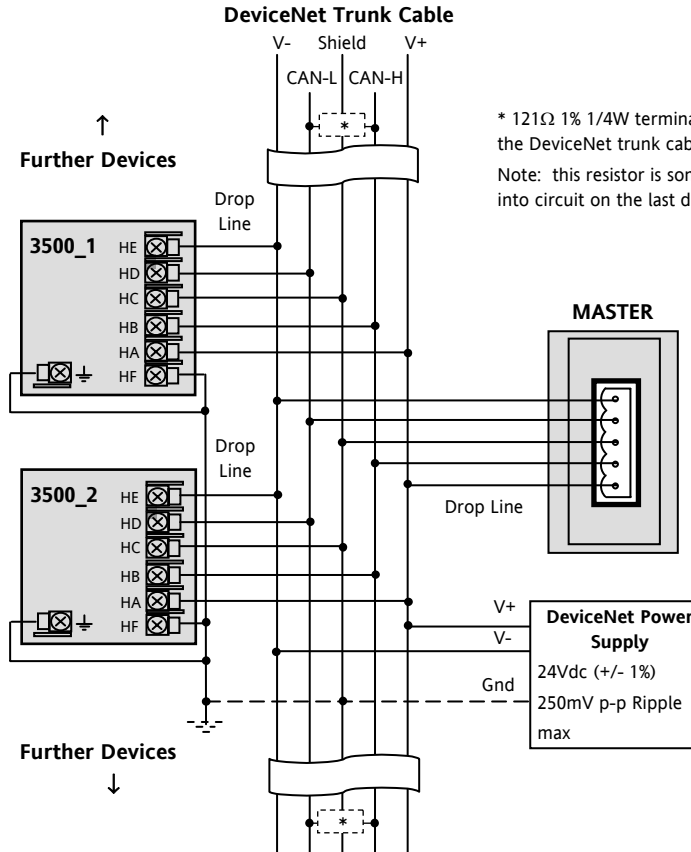

* 121Ω 1% 1/4W terminating resistor must be connected across the blue and white wires at each end of the DeviceNet trunk cable.

Note: this resistor is sometimes included in the master or other devices but should only be switched into circuit on the last device on the trunk cable.

Note:

The DeviceNet network is powered by an external independent 24V supply which is separate from the internal powering of the individual controllers.

Note: Power taps are recommended to connect the DC power supply to the DeviceNet trunk line. Power taps include:

- A Schottky Diode to connect the power supply V+ and allows for multiple power supplies to be connected.

- 2 fuses or circuit breakers to protect the bus from excessive current which could damage the cable and connectors.

The earth connection, HF, to be connected to the main supply earth terminal at one point only.

2.8.4 Profibus

A description of Profibus is given in the Profibus Communications Handbook Part No HA026290 which can be downloaded from www.eurotherm.com.

2.8.5 Example Profibus Wiring

Profibus master

(9-way D-type pinout)

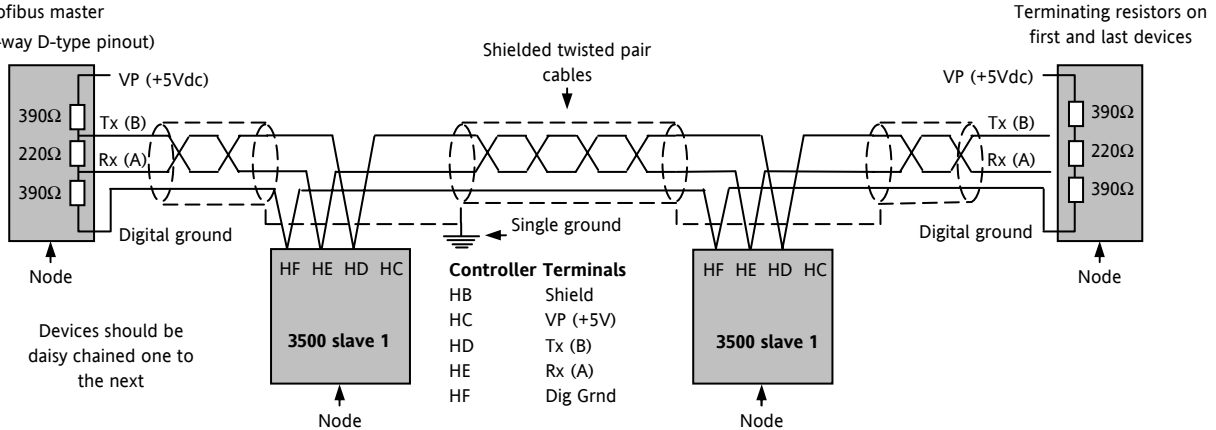

If options code PD is ordered a D Type Connector for rear terminal mounting is supplied

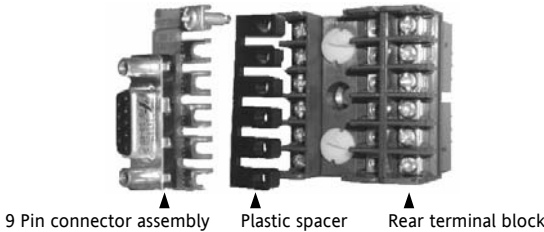

9 pin connections

- Pin 1: Shield
- Pin 3: Tx/Rx +ve
- Pin 5: Ground
- Pin 6: +5V
- Pin 8 : Tx/Rx -ve
- Pin 9: Spare

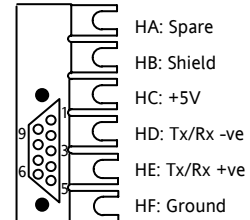

2.8.6 Ethernet (Modbus TCP)

When the controller is supplied with the Ethernet communications option a special cable assembly is also supplied. This cable must be used since the magnetic coupling is contained within the RJ45 connector. It consists of an RJ45 connector (socket) and a termination assembly which must be connected to terminals HA to HF.



View of cable which may also be ordered separately as Part No SUB3500/COMMS/EA

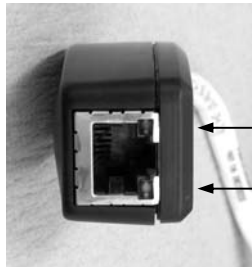

Activity and transmit data LED indicators

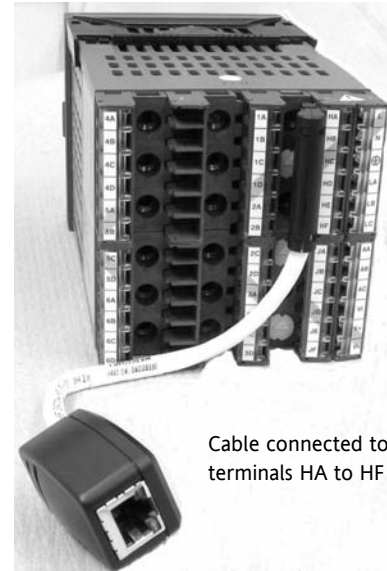

Cable connected to terminals HA to HF

2.8.7 I/O Expander

An I/O expander (Model No 2000IO) can be used with 3500 series controllers to allow the number of I/O points to be increased by up to a further 20 digital inputs and 20 digital outputs. Data transfer is performed serially via a two wire interface module (order code EX) which is fitted in digital communications slot J.

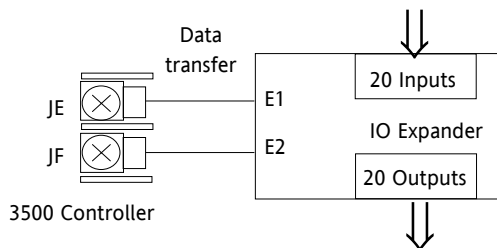
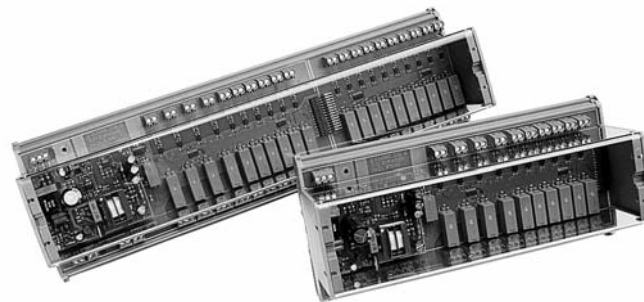

A description of the IO Expander is given in Handbook Part No HA026893 which can be downloaded from www.eurotherm.com.

The connections for this unit are reproduced below for convenience.

2.8.8 IO Expander Connections

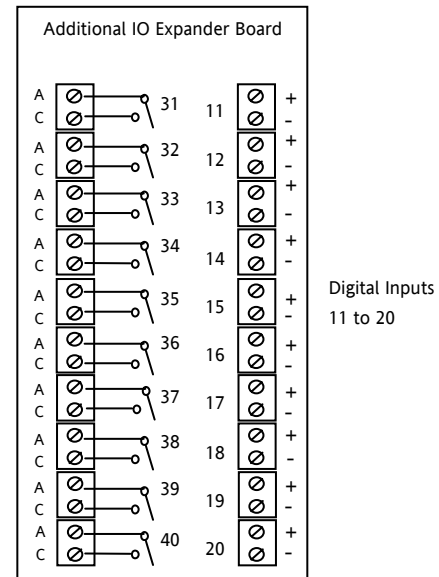
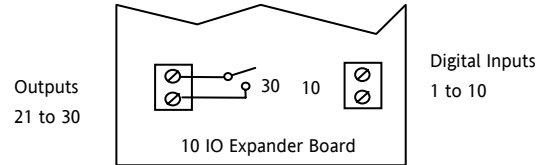
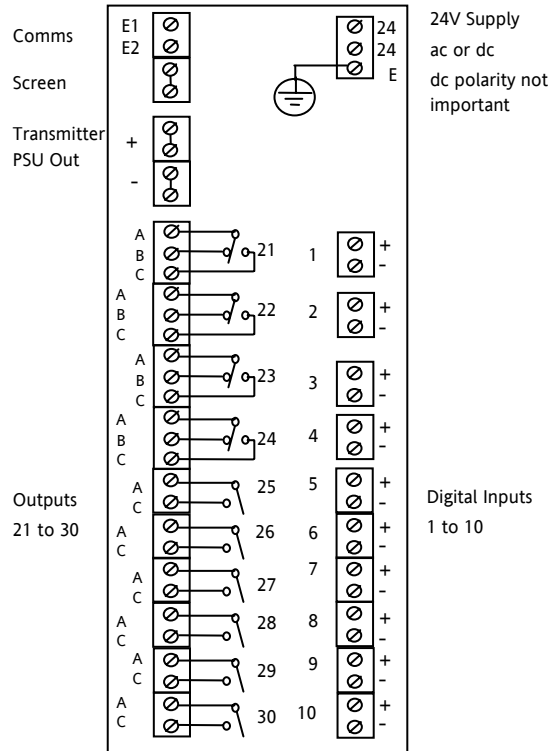

2.8.9 Example Wiring Diagram

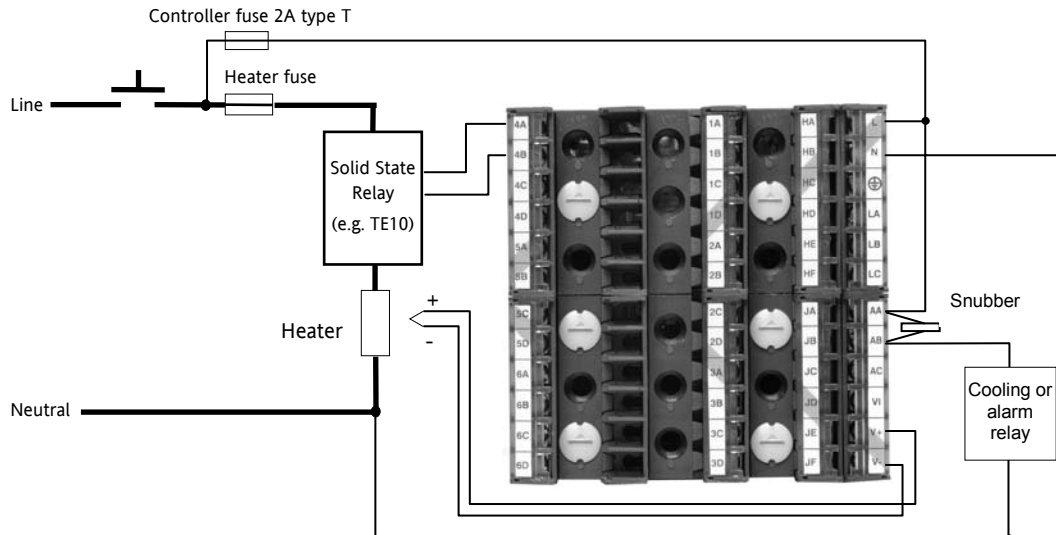

Safety requirements for permanently connected equipment state:

- A switch or circuit breaker shall be included in the building installation
- It shall be in close proximity to the equipment and within easy reach of the operator
- It shall be marked as the disconnecting device for the equipment.

Note: a single switch or circuit breaker can drive more than one instrument.

Please refer to the EMC Electromagnetic Compatibility Handbook Part No. HA025464 for further details of good wiring practice. This can be downloaded from www.eurotherm.com.

2.8.10 Snubbers

Snubbers are used to prolong the life of relay contacts and to reduce interference when switching inductive devices such as contactors or solenoid valves. The fixed relay (terminals AA/AB/AC) is not fitted internally with a snubber and it is recommended that a snubber be fitted externally, as shown in the example wiring diagram. If the relay is used to switch a device with a high impedance input, no snubber is necessary.

All relay modules are fitted internally with a snubber since these are generally required to switch inductive devices. However, snubbers pass 0.6mA at 110V and 1.2mA at 230Vac, which may be sufficient to hold on high impedance loads. If this type of device is used it will be necessary to remove the snubber from the circuit.

The snubber is removed from the relay module as follows:-

1. Unplug the controller from its sleeve
2. Remove the relay module
3. Use a screwdriver or similar tool to snap out the track. The view below shows the tracks in a Dual Relay Output module.

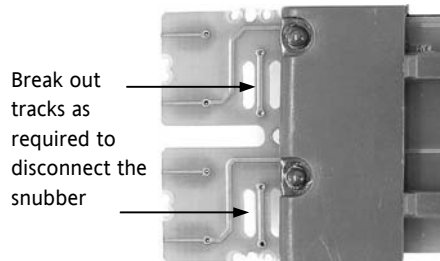

3. Chapter 3: Getting Started

A brief start up sequence consists of a self test in which all elements of the display are illuminated and the software version is shown. What happens next depends on one of two conditions:-

1. Power up out of the box – when the controller has no preset configuration and is switched on for the very first time it will start up in 'QuickStart mode'. This is an intuitive tool for configuring the controller and is described in section 3.1 below.
2. The controller has been powered up previously and is already configured. In this case go to section 3.3.

3.1 Quick Start - New Controller (Unconfigured)

Quick Start is a tool which enables the controller to be matched to the most common processes without the need to go to full configuration level described in the Engineering Manual Part No. HA027988.

When the controller is switched on for the very first time it will display the 'Startup' screen shown.



3504 Display





3508 Display



Incorrect configuration can result in damage to the process and/or personal injury and must be carried out by a competent person authorised to do so. It is the responsibility of the person commissioning the controller to ensure the configuration is correct



3.1.1 To Configure Parameters in Quick Start Mode







With 'QckStart' selected, press  to scroll through the list of parameters

Edit the parameters using the  or  buttons









Each time  button is pressed a new parameter will be presented

This is illustrated by the following example:- (The views shown are taken from the 3504 controller).

 Tip: From the Startup view, shown in the previous section, you can press  or  to select Configuration Mode. To fully configure the controller refer to the Engineering Handbook Part No HA027988.

 Tip: Backscroll – to scroll back through parameters press and hold  then press  to go back through the list of parameters. You can also press and hold  +  to go forward - this has the same effect as pressing  alone.

Example

Do This	Display	Additional Notes
<ol style="list-style-type: none"> From the Start view press  Press  or  to change the 'Units' A different parameter is selected each time  is pressed. 		<p>The first parameter to be configured is 'Units'. It resides in the 'PV Input List' because it is associated with the process variable.</p> <p>When the required choice is selected a brief blink of the display indicates that it has been accepted</p>
<ol style="list-style-type: none"> Continue setting up the parameters presented until the 'Finished' view is displayed. If all parameters are set up as required press  or  to 'Yes' 		<p>If you wish to scroll around the parameters again do not select Yes but continue to press .</p> <p>When 'Yes' is selected the controller reverts to Auto control. The 'HOME' display - section 3.3 is then shown.</p>

The following table summarises all the parameters which can be set up by the above procedure.

3.1.2 Quick Start Parameters

Parameters shown in **Bold** are defaults.

Group	Parameter	Value		Availability
LP1 PV Input	Units Used to select the engineering units for the PV. (C, F, K options also change the displayed units)	C, F, K V, mV, A, mA, pH, mmHg, psi, Bar, mBar, %RH, %, mmWG, inWG, inWW, Ohms, PSIG, %O ₂ , PPM, %CO ₂ , %CP, %/sec, Vacuum, sec, min, hrs, None		Always
LP1 PV Input	Resolution - to select the required decimal point position for the PV	XXXXX, XXXX.X, XXX.XX, XX.XXX, X.XXXX		Always
LP1 PV Input	Range Type Used to select the linearisation algorithm required and the input sensor.	Thermocouple: J, K , L, R, B, N, T, S, PL2, C, CustC1(2&3) RTD: Pt100 Linear: 0-50mV, 0-5V, 1-5V, 0-10V, 2-10V, 0-20mA, 4-20mA		Always
LP1 PV Input	IO Type Only shown if custom curve is selected	Thermocpl, RTD, Pyrometer, mV40, mV80, mA, Volts, HIZVolts, Log10		
LP1 PV Input	Range High/Low Configures the maximum/minimum display range and SP limits	Depends on Range type selected. Default 1372/-200		Always
LP1 Loop	Control Channel 1. Sets the control type for channel 1 (normally Heat)	PID , VPU, VPB, Off, OnOff	VPU = Boundless valve position control. This is a velocity mode algorithm and does not need a feedback potentiometer VPB = Bounded VP which requires a	Always
LP1 Loop	Control Channel 2. Sets the control type for channel 2	PID , VPU, VPB, Off , OnOff		Always

Group	Parameter	Value	Availability
	(normally Cool)	feedback potentiometer	
LP2 PV Input	Source Defines where the PV input is wired to	None , FixedPV, Module6. Available only if an analogue input module is fitted.	If a dual loop controller
LP2 PV Input	Units	AbsTemp select this for temperature input. Other choices are:- V. mV, A. mA, pH, mmHg, psi, Bar, mBar, %RH, %, mmWG, inWG, inWW, Ohms, PSIG, %O2, PPM, %CO2, %CP, %/sec, Vacuum, sec, min, hrs, None Note units C, F and K are not available.	If 'Source = Module6
The LP1 parameters listed above are repeated for LP2 if the LP2 PV Input is configured			
Init LgcIO LA	Logic function (input or output) The LA Logic I/O port can be an output or an input. This parameter is used to select its function.	Not Used , Lp1 Ch1, Lp1 Ch2, Lp2 Ch1, Lp2 Ch2, Alarm 1 to 8, Any Alarm, New Alarm, ProgEvt1 to 8, LP1SBrkOP, LP2SBrkOP*, LPsSBrk*, (outputs) LP1 A-M, LP1 SPsel, LP2 A-M, LP2 SPsel, AlarmAck, ProgRun, ProgReset, ProgHold (Inputs)	[Note 1] [Note 2] * LP2 and LPs (both loops) only shown if the second loop is configured Programmer options only available if the controller is a programmer/controller
Init LgcIO LA	Min OnTime	Auto 0.01 to 150.00	[Note 2] [Note 3]
The above two parameters are repeated for the LB Logic I/O (LgcIO LB)			
Init RlyOP AA	AA Relay output function This relay is always fitted.	Not Used , Lp1 Ch1, Lp1 Ch2, Lp2 Ch1, Lp2 Ch2, Alarm 1 to 8, Any Alarm, New Alarm, ProgEvt1 to 8, LP1SBrkOP, LP2SBrkOP*, LPsSBrk*.	Always. [Note 4] Programmer options only available if the controller is a programmer/controller

Group	Parameter	Value	Availability
Init	AA Relay output Min OnTime	Auto	[Note 2]
RlyOP AA		0.01 to 150.00	[Note 3]

Note 1) Parameters only appear if the function has been turned on, eg If 'Control Channel 1' = 'Off', 'Chan 1' does not appear in this list. When a control channel is configured for valve positioning, LgcIO LA and LgcIO LB act as a complementary pair. If, for example, Chan 1 is connected to LgcIO LA (valve raise) then LgcIO LB is automatically set to Chan 1 (valve lower). This ensures the valve is never raised and lowered simultaneously.

The same complementary behaviour also applies to dual output modules and channels A and C of triple output modules

Note 2) If any input function, for example Chan 1, is connected to another input it will not appear in this list

Note 3) Is available if the Control Channel is not On/Off and is allocated to the LA, LB or AA output as applicable

Note 4) For valve position control Chan 1 or Chan 2 will not appear in this list. Valve position outputs can only be dual outputs such as LA and LB or dual relay/triac output modules

3.1.2.1 Modules

The following parameters configure the plug in I/O modules. I/O Modules can be fitted in any available slot in the instrument (6 slots in 3504, 3 slots in 3508). The controller automatically displays parameters applicable to the module fitted - if no module is fitted in a slot then it does not appear in the list.

Each module can have up to three inputs or outputs. These are shown as A, B or C after the module number and this corresponds to the terminal numbers on the back of the instrument. If the I/O is single only A appears. If it is dual A and C appears if it is triple A, B and C appear.

Note 1: If a Dual DC Output module is fitted, it cannot be configured using the Quick Start Code. To configure this module refer to the Engineering Manual part no. HA027988 which can be downloaded from www.eurotherm.com.

Note 2: If an incorrect module is fitted the message 'Bad Ident' will be displayed.

Module type	Parameter	Value		Availability	
Change over relay (R4) 2 pin relay (R2) Triac output (T2)	Relay (Triac) function	Not Used All parameters the same as RlyOP AA, including Min OnTime if the OP is a relay		Always (if the module is fitted)	
	Dual Relay (RR)				Relay (Triac) function
	Dual triac output (TT)				Relay function
Single Logic Output (LO)	Logic Out function	Not Used		Always (if the module is fitted)	
Triple Logic Output (TP)		All parameters the same as RlyOP AA			
DC Output (D4) DC Retransmission (D6)	DC Output function	Not Used	Module fitted but not configured	Always (if the module is fitted)	
		LP1 Ch1OP	Loop 1 Channel 1 control output		
		LP1 Ch2OP	Loop 1 Channel 2 control output		
		LP2 Ch1OP	Loop 2 Channel 1 control output		
		LP2 Ch2OP	Loop 2 Channel 2 control output		
		LP1 SP Tx	Loop 1 setpoint retransmission		
		LP1 PV Tx	Loop 1 PV retransmission		
		LP1 ErrTx	Loop 1 error retransmission		
		LP1 PwrTx	Loop 1 output retransmission		
		LP2 SP Tx	Loop 2 setpoint retransmission		
		LP2 PV Tx	Loop 2 PV retransmission		
		LP2 ErrTx	Loop 2 error retransmission		
		LP2 PwrTx	Loop 2 output retransmission		
		Range Type	0–5V, 1–5V, 1–10V, 2–10V, 0–29mA, 4–20mA		
	Display High	100.0			

Module type	Parameter	Value		Availability
	Display Low	0		
Triple Logic Input (TL) Triple Contact Input (TK)	Logic In function	Not Used	Module fitted but not configured	A function can only be allocated to one input. eg if AlarmAck is configured on X*A it is not offered for the other inputs * is the module number. LP2 does not appear if loop 2 is not configured.
		LP1 A-M	Loop 1 Auto/manual	
		LP1 SPsel	Loop 1 SP select	
		LP1 AltSP	Loop 1 Alternative SP select	
		LP2 A-M	Loop 2 Auto/manual	
		LP2 SPsel	Loop 2 SP select	
		LP2 AltSP	Loop 2 Alternative SP select	
		AlarmAck	Alarm acknowledge	
		ProgRun	Programmer run	
		ProgReset	Programmer reset	
	ProgHold	Programmer hold		
Analogue Input (AM)	Analogue IP function	Not Used	Module fitted but not configured	LP1 V1Pos and LP1 V2Pos only appear if the control channel 1 or control channel 2 is set to VPB. Remote SP does not appear if the programmer option is supplied. LP2 does not appear if loop 2 is not configured.
		LP1 AltSP	Loop 1 alternative setpoint	
		LP1 OPH	Loop 1 remote OP power max	
		LP1 OPL	Loop 1 remote OP power min	
		LP2 AltSP	Loop 2 alternative setpoint	
		LP2 OPH	Loop 2 remote OP power max	
		LP2 OPL	Loop 2 remote OP power min	
		LP1 V1Pos	To read valve position from the feedback potentiometer loop 1	
		LP1 V2Pos		
		LP2 V1Pos	To read valve position from the feedback potentiometer loop 2	
LP2 V2Pos				

Module type	Parameter	Value	Availability	
	Range Type	Thermocouple: J, K, L, R, B, N, T, S, PL2, C. RTD: Pt100 Linear: 0-50mV, 0-5V, 1-5V, 0-10V, 2-10V, 0-20mA, 4-20mA	Not shown if analogue IP function not used	
	Display High	100.0	These parameters only appear for Linear Range	
	Display Low	0.0		
Potentiometer Input (VU)	Pot Input function	Not Used	Module fitted but not configured	Ch1VlvPos/Ch2VlvPos only appear if the channel = VPB Remote SP does not appear if the programmer option is supplied. LP2 does not appear if loop 2 is not configured.
		LP1 AltSP	Loop 1 Alternative setpoint	
		LP1 OPH	Loop 1 output power maximum	
		LP1 OPL	Loop 1 output power minimum	
		LP2 AltSP	Loop 2 Alternative setpoint	
		LP2 OPH	Loop 2 output power maximum	
		LP2 OPL	Loop 2 output power minimum	
		LP1 V1Pos	To read valve position from the feedback potentiometer loop 1	
		LP1 V2Pos		
		LP2 V1Pos	To read valve position from the feedback potentiometer loop 2	
LP2 V2Pos				
Transducer Power Supply (G3)	TdcrPSU function	5 Volts 10 Volts	Always (if the module is fitted)	
Transmitter power supply (MS)	No parameters. Used to show the ID of the module if fitted			

Quick Start parameters continued on next page.





3.1.2.2 Alarms

Group	Parameter	Value		Availability
Init Alarm 1 to 8	Type	None	No alarm type configured	Always
		Abs High	Absolute high	
		Abs Low	Absolute low	
		Dev High	Deviation high	
		Dev Low	Deviation low	
		Dev Band	Deviation band	
Init Alarm 1 to 8	Source	None	Not connected	Always if Type ≠ None PV Input and ModX Ip do not appear if Type = Deviation
		PV Input	Connected to main process variable does not appear if Alarm Type = Deviation	
		LP1 PV	Connected to Loop 1 process variable	
		LP2 PV	Connected to Loop 2 process variable	
		Module1 - Module6	Connected to an analogue input module and only of the Alarm Type is not a deviation alarm	
Init Alarm 1 to 8	Setpoint	To adjust the alarm threshold within the range of the source.		Always if Type ≠ None
Init Alarm 1 to 8	Latch	None	No latching	Always if Type ≠ None
		Auto	Automatic latching see section 3.7.1	
		Manual	Manual latching see section 3.7.1	
		Event	Alarm beacon does not light but any output associated with the event will activate and a scrolling message will appear.	
Finished	Exit	No	Continue back around the quick configuration list	
		Yes	Go to normal operation. The loop(s) are set to Auto on exit from quickstart mode and the controller re-starts in Level 2.	

3.2 To Re-enter Quick Start Mode

If you have exited from Quick Start mode (by selecting 'Yes' to the 'Finished' parameter) and you need to make further changes, the Quick start mode can be entered again at any time. The action which takes place depends on one of two previous conditions as follows:-

3.2.1 Power up After a Quick Start Configuration

1. Hold  down then power up the controller. Keep this button pressed until the Quick start screen as shown in section 2.1 is displayed.
2. Press  to enter the quick start list. You will then be asked to enter a passcode.
3. Use  or  to enter the passcode – default 4 – the same as the configuration level passcode. If an incorrect code is entered the display reverts to the 'Quick Start' view section 2.1.

It is then possible to repeat the quick configuration as described previously.





The Quick Start view shown in section 3.1 now contains an additional parameter - '**Cancel**'. This is now always available after a power up, and, if selected, will take you into normal operating mode, section 3.3.

3.2.2 Power up After A Full Configuration

Repeat 1,2 and 3 above.

Full configuration allows a greater number of parameters to be configured in a deeper level of access. This is described in the Engineering Handbook Part No. HA027988.

If the controller has been re-configured in this level, a '**WARNING**' message, '**Delete config?**' - '**No**' or '**Yes**', will be displayed. If 'No' is selected the display drops back to the 'GoTo' screen.

1. Use  or  to select 'Yes'
2. Press  to confirm or  to cancel. (If no button is pressed for about 10 seconds the display returns to the WARNING message).

If 'Yes' is selected the **Quick start defaults** will be re-instated. **All** the Quick start parameters must be reset.

3.3 Normal Operation

Switch on the controller. Following a brief self-test sequence, the controller will start up in AUTO mode (see AUTO/MAN section 3.6) and Operator Level 2 (following Quick Start).

If the controller is configured as a dual loop instrument the start up view shows a summary of the two loops. This is called the HOME display.

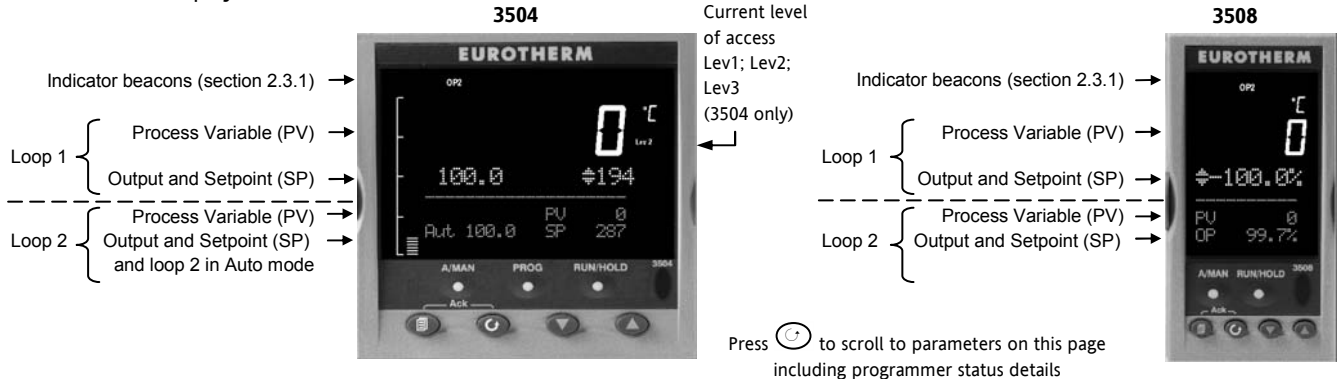



If the controller is configured as a dual loop the HOME displays will vary as shown below:-



Other views may be configured as the HOME display and other summary displays can be selected using [Home] button. See Summary Pages section 3.8.

3.3.1 Beacon Display and Description





Beacon	Description
OP1	Illuminates when output 1 is ON (normally heating)
OP2	Illuminates when output 2 is ON (normally cooling or alarm)
MAN	Illuminates when manual mode active. If the HOME display is showing the dual loop overview, MAN illuminates if Loop 1 is in manual. If the Loop 1 or Loop 2 overviews are being displayed MAN applies to the loop being displayed.
REM	Illuminates when alternative setpoint is active
SPX	Illuminates when setpoint 2 is active
ALM	<p>If an alarm occurs the red alarm beacon flashes. This is accompanied by a message showing the source of the alarm, for example 'Boiler overheating'.</p> <p>To acknowledge press  and . The message disappears. If the alarm condition is still present the beacon lights continuously. When cleared it will extinguish. A description of the alarm operation is given in section 3.7</p>
RUN	Illuminates when programmer running – flashing indicates End
HLD	Illuminates when programmer held
J	Flashes when J Channel comms active
H	Flashes when H Channel comms active
IR	Flashes when infra red communications active

In general throughout this handbook instrument views will use the 3504. The displayed information is similar for the 3508 but in some cases is shortened due to display limitations.

3.4 The Operator Buttons





















Page Scroll Lower Raise

<p>A/MAN</p> <p>This button can be disabled</p>	<p>Toggles the selected loop between Auto and Manual operation. The action of this button is described in section 3.6.</p> <p>Manual operation means that the controller output power is adjusted by the user. The input sensor is still connected and reading the PV but the control loop is open.</p> <p>Auto means that the controller is automatically adjusting the output to maintain control, ie the loop is closed.</p> <p>If the controller is in manual mode, 'MAN' light will be indicated.</p> <p>If the controller is powered down in Manual operation it will resume this mode when it is powered up again.</p>
<p>PROG</p>	<p>To select the programmer summary page</p>
<p>RUN/HOLD</p> <p>This button can be disabled</p>	<p>Press once to select a program. Press again to run the selected program. 'RUN' will be indicated in the top banner of the display.</p> <p>Press again to hold a program. 'HLD' will be indicated</p> <p>Press and hold for at least two seconds to reset a program.</p> <p>'RUN' will flash at the end of a program</p> <p>'HLD' will flash during holdback</p> <p>Programmer operation is fully described in chapter 21 of the Engineering Manual</p>
	<p>Press to select new PAGE headings</p>
	<p>Press to select a new parameter in the page</p>
	<p>Press to decrease an analogue value, or to change the state of a digital value</p>
	<p>Press to increase an analogue value, or to change the state of a digital value</p>

3.4.1 Shortcut Key Presses

The following Short Cut Key presses are provided:-

Action	Key Presses
Backpage	Press  followed by  . With  held down continue to press  to scroll page headers backwards. (With  still pressed you can press  to page forward. This action is the same as pressing  alone).
Backscroll	When in a list of parameters, press  followed by  . With  held down continue to press  to scroll parameters backwards. (With  still pressed you can press  to page forward. This action is the same as pressing  alone).
Jump to HOME display	Press  + 
Alarm Ack/reset	Press  +  when the HOME screen is being displayed to jump to the 'Acknowledge All alarms' page. Pressing  acknowledges all alarms if it can, see section 3.7.1. Pressing  cancels the operation.

3.5 To Set The Required Temperature (Setpoint)

A parameter value can be changed if it is preceded by \blacklozenge . In the example shown below this is the setpoint for loop 1.

To change the value, press \blacktriangledown or \blacktriangle . The output level shown in the HOME display will change to indicate the source of the setpoint while either of the buttons is pressed, in this example SP 1.

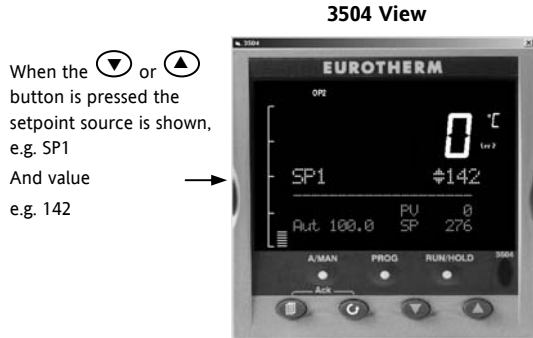

When the \blacktriangledown or \blacktriangle button is pressed the setpoint source is shown, e.g. SP1
And value e.g. 142

Press and hold \blacktriangledown to lower the setpoint

Press and hold \blacktriangle to raise the setpoint

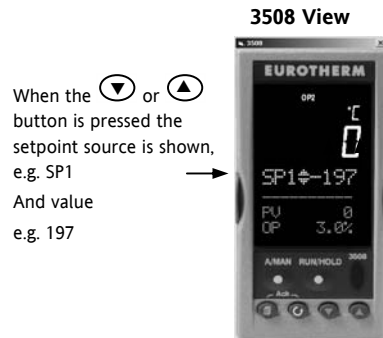

When the \blacktriangledown or \blacktriangle button is pressed the setpoint source is shown, e.g. SP1
And value e.g. 197

Press and hold \blacktriangledown to lower the setpoint

Press and hold \blacktriangle to raise the setpoint

To change Loop 2 setpoint, press \blacklozenge . Loop 2 SP value is preceded by \blacklozenge . Press \blacktriangledown or \blacktriangle as above to change the value. The action is then the same as for loop 1. A momentary press of either button will show the setpoint in use eg SP1.

The new setpoint is accepted when either \blacktriangledown or \blacktriangle is released and is indicated by a brief flash of the setpoint display

If a single loop is configured (or the individual loop summary is selected – see section 3.8.4) pressing \blacktriangledown or \blacktriangle will change the setpoint in the same way as described above.

3.6 To Select Manual Operation



Press (A/MAN) button.

If two loops are enabled and the dual loop overview is being displayed, pressing the A/MAN button will toggle loop 1 between Auto and Manual. The beacon 'MAN' will light and the indication of output power is preceded by ∇ .

Press and hold ∇ or \blacktriangle to decrease or increase the output power.

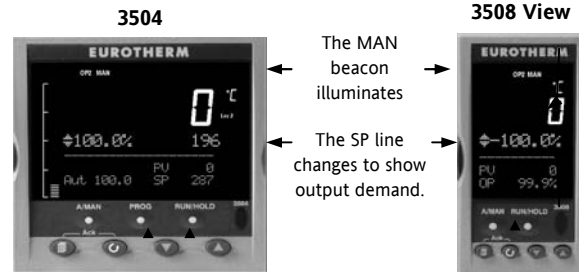

The output power will change continuously while either ∇ or \blacktriangle is pressed

To switch loop 2 between Auto and Manual, press \odot to scroll into the loop 2 section, then press A/MAN.

If loop 1 overview is being displayed, press the A/MAN button to toggle loop 1 between Auto and Manual.

If loop 2 overview is being displayed, press the A/MAN button to toggle loop 2 between Auto and Manual.

If any other overview is being displayed, the first press of the A/MAN button will select the dual loop overview and the action is as described above.

\odot Tip: Summary pages may be disabled in configuration level. If none of the above summary pages are enabled:-

- For a dual loop controller, Auto/Manual cannot be selected.
- If loop 1 is enabled and loop 2 disabled, pressing A/MAN toggles Auto/Manual for loop 1.
- If loop 2 is enabled and loop 1 disabled, pressing A/MAN toggles Auto/Manual for loop 2.

\odot Tip: For a single loop controller, Auto/Manual will apply regardless of whether summary pages are enabled or not.

\odot Tip: If the controller is switched off in either Auto or Manual it will resume the same mode when powered up again.



3.7 Alarm Indication

If an alarm occurs it is indicated as follows:-

The red alarm (ALM) beacon in the top left of the display flashes

Alarm number is indicated together with the flashing 

A default or pre-programmed message appears showing the source of the alarm

Invitation to acknowledge the new alarm



3.7.1 To Acknowledge an Alarm

Press  and  (Ack) together.

The action, which now takes place, will depend on the type of latching configured

Non Latched Alarms

If the alarm condition is present when the alarm is acknowledged, the alarm beacon will be continuously lit. This state will continue for as long as the alarm condition remains. When the alarm condition disappears the indication will also disappear.

If a relay has been attached to the alarm output, it will de-energise when the alarm condition occurs and remain in this condition until the alarm is acknowledged **AND** it is no longer present.

If the alarm condition disappears before it is acknowledged the alarm indication disappears at the same time.

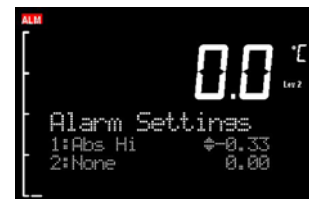

Automatic Latched Alarms

The alarm continues to be active until both the alarm condition is removed AND the alarm is acknowledged. The acknowledgement can occur **BEFORE** the condition causing the alarm is removed.

Manual Latched Alarms

The alarm continues to be active until both the alarm condition is removed AND the alarm is acknowledged. The acknowledgement can only occur **AFTER** the condition causing the alarm is removed.

3.7.2 Sensor Break Indication

An alarm condition (**Sbr**) is indicated if the sensor or the wiring between sensor and controller becomes open circuit or the input is over-range. The message 'Sbreak' is shown in the message centre together with the source of the sensor connection. This may be 'PVIinput' or 'Modx' if an analogue module is fitted.

For a resistance thermometer input, sensor break is indicated if any one of the three wires is broken.

For mA input sensor break will not be detected due to the load resistor connected across the input terminals.

For Volts input sensor break may not be detected due to the potential divider network connected across the input terminals.

3.8 Summary Pages

The lower section of the HOME display contains an alpha-numeric message centre. These messages change between different controller types and operating modes and are grouped in summary pages. In addition, each page may be turned on or off in configuration level but, in this section, all possible summary pages are listed. Because of its larger display area the 3504 generally shows more detail than that shown in 3508.

Press  to scroll through a set of pre-defined summary pages. These are typically a summary of programmer, loops and alarm operation. The views shown in this section are typical and may vary from controller to controller.

A further eight customised pages and the operating level in which the summary pages are shown can be configured using iTools programming software⁽¹⁾.

A timeout may be set in configuration level ⁽¹⁾ after which the display reverts to the normal HOME display.

(1) see Engineering Handbook, Part No HA027988 which can be downloaded from www.eurotherm.com.

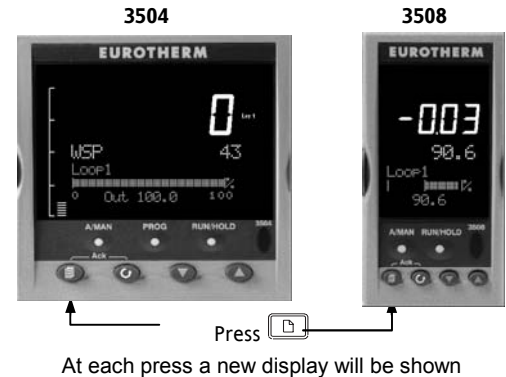

3.8.1 Navigation of Summary Pages

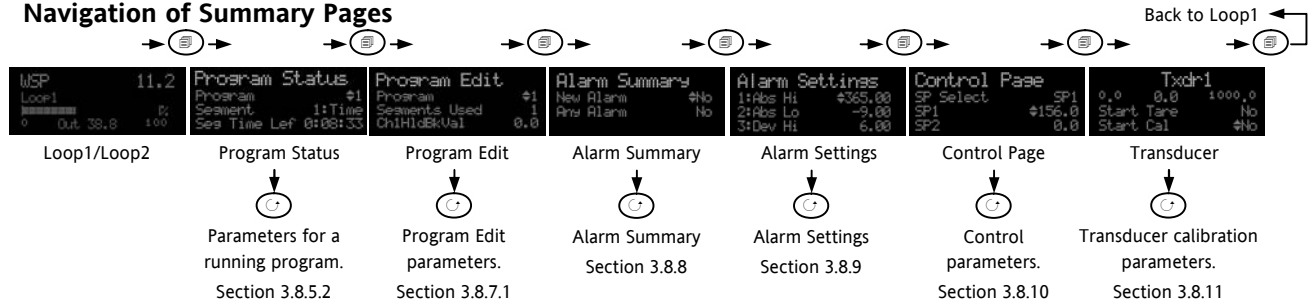

3.8.2 How to Edit Parameters

In any of the summary pages, press  to scroll to further parameters (where applicable).



Press  or  to change the value of the parameter selected.

Any parameter preceded by  is alterable provided the system is in a safe state to allow the parameter to be changed. For example, 'Program Number' cannot be changed if the program is running - it must be in 'Reset' or 'Hold' mode. If an attempt is made to alter the parameter its value is momentarily replaced by '---' and no value is entered.

3.8.3 Access Level 2

Some parameters are protected under a higher level of security – Level 2. In these cases it will be necessary to select 'Access Level 2'. This is carried out as follows:-



1. Press and hold  until the display shows
2. Press  to select Level 2
3. Press  again to enter a security code. This is defaulted to 2. If an incorrect code is entered the display reverts to that shown in 1 above. If the default of 2 is not accepted this means that the code has been changed on your particular controller. It will be necessary to refer to the Engineering Handbook.

'Pass' is displayed momentarily. You are now in Level 2.

3.8.4 Loop Summary

If the selected loop is in Auto the current setpoint value is shown together with the current value of the output power demand shown both as a value and graphically.



If the loop is in Manual mode only the output demand is shown.

If the loop is configured for channel 1 and channel 2, for example, **heat/cool**, the bar graph is bi-directional (+ 100%) as shown:-



If the controller is configured for **valve position** control the user interface will display either heat only or heat/cool summary pages.

Press  again to display a summary for Loop 2.

If both loops are configured the display in section 3.3 is shown.

3.8.5 Program Status Summary

From this page you can select to, Run, Reset or Hold a program and inspect the status of a running program.

It is only shown if the Programmer option has been ordered and enabled.

A programmer varies the rate of change of setpoint and allows a profile to be set up and run.









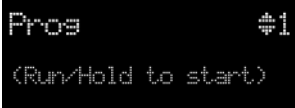

Two program channels are available which can be

run as two separate programmers or as a pair. As a pair they may be configured as **'SyncStart'** where the each programme is synchronised to start at the same time or **'SyncAll'** in which the program automatically synchronises at the end of every segment. Alternatively, only a single program may be run. Up to 50 programs and up to a maximum of 500 segments can be stored and run. Setpoint programming is explained in detail in the 3500 Engineering Manual HA027988.



3.8.5.1 To Select and Run a Program

This example assumes the program to be run has already been entered. To set up or edit a program, see section 3.8.6.

Action	Do This	The Display You Should See	Additional Notes
Select a Program to run	1. Press  2. Press  or  to choose the program number to be run		In this example Program Number 1 is selected. It may also have a user defined name. In the 3504 Program names can be entered using the off-line programming package 'iTools'
Run the selected program	3. Press  again		If a delayed start has been configured the program will start to run after the delay period set.. The 'RUN' beacon is illuminated at the top of the display. The view shown here shows program being run, segment number and type and time left to complete this segment.
Select parameters of an operating program	4. Press  repeatedly to scroll through parameters as listed in the table in section 3.8.5.2.		These show current value of channel 1 setpoint and current value of channel 2 setpoint. The target value of channel 1 is also shown.
Hold a program	5. Press 		Press  again to continue the program. When the program is complete 'RUN' will flash
Reset a program	6. Press and hold  for at least 3 seconds		'RUN' will extinguish and the controller will return to the HOME display shown in section 3.3.

Alternatively, run, hold or reset a program by scrolling to 'Program Status' using  and select 'Run', 'Hold' or 'Reset' using  or .

The  button (3504 only) provides a short cut to the Program Status page from any view.

3.8.5.2 To Inspect/Change the Status of a Running Program

The table in this section lists parameters associated with a program currently in operation. These parameters may be used to inspect the status of the program such as which segment is in operation, time left, etc. In some cases, as stated in the table, the parameter values may be changed.

From the Program Status page, press  to scroll through a list of parameters. These are:-



```

Program Status
Program          #1
Segment          1:Time
Seg Time Left   0:08:21
  
```

Parameter Name	Parameter Description	Value		Default	Available in Level
Program	Program number (and name if this has been configured)	1 to max number of programs		1	L1 Alterable when prog in reset
Segment	Segment number (and type on 3504) Only appears when the programmer is running	1 to max number of segments			Read only
Seg Time Left	Segment Time Left Only appears when the programmer is running	hrs:mins:secs			Read only
Delayed Start	Program will run after a set time has elapsed. Only shown if delayed start has been configured.	0:00 to 499:99		0:00	L1 if configured
Status	Program Status. Note, the program can be run or held from this parameter as well as using the Run/Hold button.	End Run Hold Holdback	Prog ended Prog running Prog held In holdback ⁽¹⁾		L1
Ch1 PSP (or PSP)	Profile setpoint value channel 1				L1 Can be changed in Hold
Ch2 PSP	Profile setpoint value channel 2				

Parameter Name	Parameter Description	Value	Default	Available in Level
Fast Run	This allows the program to be run at a fast rate and may be used for testing the program. It can only be selected before the program is run.	No/Yes	No	L1
Rst UsrVal	User value to be used in reset state. Defines the value for 'UsrValOP'. In segments that specify 'PVEvent', 'UsrValOP' is set to this value Only appears when the program is in reset mode.			
Ch1 Seg Target (or Segment Target)	Requested setpoint at end of segment			
Ch2 Seg Target				
Seg. Duration (or Segment Rate)	Segment time – Time to Target programmer Rate of change of SP – Ramp Rate programmer			
Cur. Seg Type	Single programmer only			
Cycles Left	Number of repeat cycles left to run Can only be changed in Hold or Reset	1 to maximum number of cycles set		L1 R/O in Run
Events or Rst Events	State of the event outputs when the program is running or when in reset	<input type="checkbox"/> Event inactive <input checked="" type="checkbox"/> Event active		
PrgTimeLeft	Time remaining to end of selected program	hrs:mins:secs		
GoBackCyclesLeft ⁽²⁾	This parameter displays the number of cycles left if Go Back is configured and active	1 to maximum number of cycles set		

(1):- Holdback

Holdback freezes the program if the process value (PV) does not track the setpoint (SP) by more than a user defined amount. The instrument will remain in HOLDBACK until the PV returns to within the requested deviation from setpoint. The display will flash the HOLD beacon.

In a **Ramp** it indicates that the PV is lagging the SP by more than the set amount and that the program is waiting for the process to catch up.

In a **Dwell** it freezes the dwell time if the difference between the SP and PV exceeds the set limits.

In both cases it maintains the correct dwell period for the product. A more detailed description of Holdback is given in the 3500 Engineering Handbook which may be downloaded from www.eurotherm.com.

In addition to the usual PV Holdback, Holdback is also the state when synchronisation is taking place.

- For a SyncAll programmer, this occurs if Holdback has caused one PSP to be held back while the other has progressed to completion.
- For a SyncStart programmer, this occurs when Ch1/2 is waiting for the other channel.

In both models, it occurs when a Wait segment has been configured and is active. When one channel has reached the end of the first cycle and is waiting for the other channel to complete its first cycle. Both channels will start cycle 2 only when they have both completed. (Implied Sync point at the end of each cycle).

(2):- GoBack

'Go Back' allows segments in a program to be repeated a set number of times. It is useful where it is required to cycle a part of a program within an overall program as illustrated and makes best usage of the number of segments available.

For example, the simple program illustrated uses 7 segments. If it were to use individual segments it would use $10 \times 3 + 4 = 34$ segments. It would also take longer to set up. Further details can be found in Engineering Handbook, Part No HA027988

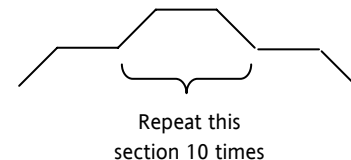

3.8.6 Program Edit Summary

Allows the program to be created or edited.

Note:- For a SyncStart programmer it is possible to select between Channel 1 and Channel 2.

SyncAll programmer →

```

Program Edit
Program          #1
Segments Used    1
Ch1HldBkVal     0
    
```

3508

```

ProgEdit
Program          #1
    
```

SyncStart and single programmers →

```

Program Edit
Pr#1             Ch1
Segments Used    2
Holdback Value   0
    
```







```





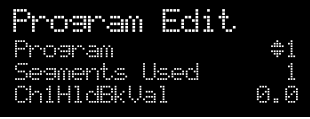



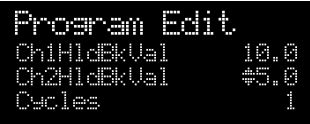



ProgEdit
Pr#1 Ch1
    
```













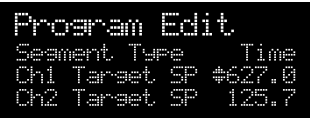

3.8.7 To Create or Edit a Program

A program can be edited in any level. A summary of the Edit Page is given here but for a full description refer to Chapter 22 in the Engineering Manual HA027988. A program may be only edited when it is in Reset or Hold. The views below are taken for a SyncAll programmer.

From the Program Edit summary page:-

Action	Do This	The Display You Should See	Additional Notes
Select a Program to edit	<ol style="list-style-type: none"> Press  to select 'Program' Press  or  to choose the program number. 		<p>In this example Program Number 1 is selected. It may also have been given a user defined name.</p> <p>In the 3504 Program names can be entered using the off-line programming package 'iTools'.</p> <p>'Segments Used' is a read only parameter.</p>
Set up the value at which holdback becomes operative	<ol style="list-style-type: none"> Press  again to select 'Ch1/2HldBkVal'. Press  or  to choose the holdback value for ch1/2. 		<p>See previous page for a description of holdback.</p>

Action	Do This	The Display You Should See	Additional Notes	
Set up the number of times a program is repeated	5. Press  again to select 'Cycles'. 6. Press  or  to choose the number of repeat cycles.		The complete program may be run once or repeated up to 999 times. In this example the program will be repeated six times.	
Set up or edit a segment	7. Press  to select 'Segment' 8. Press  or  to choose the segment number		Up to 50 segments are available in any one program.	
Set up the segment type	9. Press  to select 'Segment Type' 10. Press  or  to choose the segment type		The following choices are available, depending on programmer type. For example SyncAll offers Wait, Time and End only:-	
			Rate	Rate of change of SP
			Time	Time to target
			Dwell	Soak at constant SP
			Step	Step change to new SP
			Wait	Wait for condition
			GoBack	Repeat previous segs
			Call	Insert new program
End	Final segment			

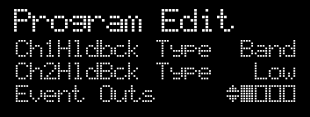
Action	Do This	The Display You Should See	Additional Notes
Set up the value of SP required at the end of the segment	11. Press  to select 'Target SP' for Ch1 and Ch2. 12. Press  or  to choose the value		This can be set within the limits of the controller range
Set up the segment time	13. Press  to select 'Duration'. 14. Press  or  to choose the value		In this example channel 1 will change from its current value to 627.0 in 5 hours 2 minutes. Channel 2 will change from its current value to 125.7 in the same time period.
Set up 'Holdback Type'	15. Press  to select 'Ch1/2HldBck Type'. 16. Press  or  to choose the value		Deviation between SP and PV at which the program is put into a hold condition to wait for the PV to catch up. Only appears if configured.
Set up which events operate in the segment	17. Press  to select 'Event Outs'. 18. Press  or  to turn the event on or off.		In this example 4 events have been configured (see Engineering handbook). The first event (which may be wired to a relay output) will be operative during the chosen segment.

Repeat the above procedure for further segments required in the program. The final segment should be configured as 'End' You can then set up the action required at the end of the program. This may be 'Dwell', 'Reset' or 'SafeOP'.

Further parameters are available in deeper levels of access and are explained in the Engineering Manual HA027988.

3.8.7.1 Program Edit Summary Parameters

The table below shows a list of all possible parameters which may be set up in operator levels 1 and 2 using the procedure in the above example. Parameters only appear in the controller if the relevant option has been configured. Further details are provided in the Engineering Handbook HA027988.

Para Name	Parameter Description	Value	
Program	Program number (and name if this has been configured)	1 to max number of programs	
Segments Used	Displays the number of segments in the program. This value automatically increments each time a new segment is added	1 to max number of segments	
Ch1HldBkVal	Channel 1 holdback value	0 to 99999	
Ch2HldBkVal	Channel 2 holdback value	0 to 99999	
Cycles	Number of times the whole program repeats	Cont 1 to 999	Continuous Repeats 1 to 999 times
Segment	To select the segment number	1 to 50	
Segment Type	Defines the type of segment. The type of segment varies depending on whether the program is Single, SyncAll or SyncStart. Call only available in single programmer Rate, Dwell, Step not available in SyncAll programmer	Rate	Rate of change of SP
		Time	Time to target
		Dwell	Soak at constant SP
		Step	Step change to new SP
		Wait	Wait for condition
		GoBack	Repeat previous segs
		Call	Insert new program
		End	Final segment
Target SP	Value of SP required at the end of the segment. For a dual channel controller, channel 1 and channel 2 can be set independently.	Range of controller	
Ramp Rate	Rate of change of SP. Only shown if the Segment Type = Rate.	Units/sec, min or hour	

Para Name	Parameter Description	Value	
Holdback Type	Deviation between SP and PV at which the program is put into a hold condition to wait for the PV to catch up. Only appears if configured	Off Low High Band	No holdback PV<SP PV>SP PV<>SP
PV Event	To set the analogue PV event in the selected segment. If PV Event ≠ None it is followed by 'PV Threshold' which sets the level at which the event becomes active. Only appears if configured	None Abs Hi Abs Lo Dev Hi Dev Lo Dev Band	No PV Event Absolute high Absolute low Deviation high Deviation low Deviation band
Time Event	To allow an On Time and an Off Time to be set in the first program event output. If set to 'Event1' an On time parameter and an Off Time parameter follow. Only appears if configured	Off Event1	
UsrVal	Sets the value of an analogue signal which can be used in the segment. Only appears if configured. Using iTools configuration package, it is possible to give this parameter an 8 character name.	Controller range	
PID Set	To select the PID set most relevant to the segment. Only appears if configured	Set1, Set2, Set3	
Event Outs	Defines the state of up to eight digital outputs. The number of event outputs can be configured in configuration level or using iTools as described in the Engineering Manual. Only the number of events configured are shown.	□□□□□□□□ to ■■■■■■■■ or τ□□□□□□□□ to ■■■■■■■■ τ = Time event: □ = event off; ■ = event on	
Duration	Time for a Dwell or Time segment. Only shown if Segment Type = Time.	0:00:00 to 500.00 secs, mins or hours	

Para Name	Parameter Description	Value	
GSoak Type	Applies a guaranteed soak in a Dwell segment. If configured is followed by a G.Soak Value	Off, Low, High, Band	
End Type	Defines the action to be taken at the end of the program	Dwell	Continue at current SP
		SafeOP	Go to a defined level
		Reset	Reset to start of prog
Wait For	Only appears if the segment is set as Wait. Defines the condition that the program should wait for.	PrgIn1	The first four parameters are digital values which can be wired to suitable sources
		PrgIn2	
		PrgIn1n2	
		PrgIn1or2	
		PVWaitIP	Analogue wait value
PV Wait	Only appears if 'PVWaitIP' is configured and defines the type of alarm which can be applied. If this parameter is configured it is followed by 'Wait Val' which allows the trip level to be set for the condition to become true	Ch2Sync	A Ch2 segment input
		None	No wait
		Abs Hi	Absolute high
		Abs Lo	Absolute low
		Dev Hi	Deviation high
		Dev Lo	Deviation low
GoBack Seg	Only appears if the segment type is 'GoBack'. It defines the segment to return to to repeat that part of the program	Dev Band	Deviation band
		1 to the number of segments defined	
GoBack Cycles	Sets the number of times the chosen section of the program is repeated	1 to 999	
Call Program	Only applies to single program and only if the segment is 'Call'. Enter the program number to be inserted in the segment	Up to 50 (current program number excluded)	
Call Cycles	Defines the number of times the called program repeats	Cont	Continuous
		1 to 999	Once to 999 times

3.8.8 Alarm Summary



Press  to scroll through the alarms.

A New Alarm occurs when any new alarm becomes active. This parameter may be used to activate a relay output to provide external audible or visual indication.

Parameters available are:-

New Alarm Shows 'Yes' when any new alarm occurs (read only)

Any Alarm Shows 'Yes' when any alarm is active (read only)

Ack All? Press  or  to acknowledge all alarms

AnaAlm 1 Shows 'Yes' when analogue alarm 1 is active (read only)

AnAlm1 Ack Press  or  to acknowledge analogue alarm 1

The above two parameters are repeated for all analogue alarms which have been configured (up to 8)

DigAlm 1 Shows 'Yes' when digital alarm 1 is active (read only)

DgAlm1 Ack Press  or  to acknowledge digital alarm 1

The above two parameters are repeated for all digital alarms which have been configured (up to 8)



```
Alarm Summary
New Alarm      #No
Any Alarm      No
```





```
Alm Smary
New Alarm
#No
```

3.8.9 Alarm Settings Summary

All configured analogue alarms (up to eight) will be listed.

Press  to scroll through the alarms.

Press  or  to set the threshold values



```
Alarm Settings
1:Abs HI      #365.00
2:Abs Lo      -9.00
3:Dev HI      6.00
```



```
Alm Sets
1: #365.00
2: -9.00
3: 6.00
```

3.8.10 Control Summary

A Control Summary page is available for both channels. Here you can select and adjust parameters which define the operation of the loops.

On the Control Summary page the following parameters are available:-

```
Control Page
SP Select      SP1
SP1            #156.0
SP2            0.0
```

```
Control
SP            #SP1
SP1          155.6
SP2           0.0
```

Parameter Name	Parameter Description	Value	Default	Availability
SP Select	To select SP1 or SP2	Between range limits set in higher levels of access	As order code	Lev1
SP1	To set the value of SP1			Lev1
SP2	To set the value of SP2			Lev1
SP Rate	To set the rate at which the setpoints change			Lev 1 alterable in Lev2
Tune*	To start self tuning (Level 2 only). When set to 'On' auto-tuning is started. Auto tune sets the 3 term control parameters PB, Ti, Td, CBH, CBL and R2G. A full description is given in the Engineering Handbook HA027988.	Off, On	Off	* Parameter does not appear if control is configured for On/Off
PB*	To set proportional band	0 to 99999		
Ti*	To set integral time	Off to 99999		
Td*	To set derivative time	Off to 99999		
R2G*	To set relative cool gain	0.1 to 10.0		
CBH*	To set cut back high	Auto to 99999		
CBL*	To set cut back low	Auto to 99999		
OP Hi	To set a high limit on the control output	-100.0 to 100.0%	100.0	
OP Lo	To set a low limit on the control output	-100.0 to 100.0%	0.0	
Ch1 OnOff Hyst	Channel 1 hysteresis (Only if configured and for On/Off control)	0.0 to 200.0	10	
Ch2 OnOff Hyst	Channel 2 hysteresis (Only if configured and for On/Off control)			

Parameter Name	Parameter Description	Value	Default	Availability
Ch2 DeadB	Channel 2 deadband. To set the period in which there is no output from either channel. (This does not appear if channel 2 is not configured)	Off to 100.0		Lev 1- alterable in Lev2
Ch1 TravelT	Motor travel time if valve control output on channel 1	0.0 to 1000.0 sec		
Ch1 TravelT	Motor travel time if valve control output on channel 1	0.0 to 1000.0 sec		
Safe OP	To set an output level under sensor break conditions	-100.0 to 100.0%	0.0	

3.8.11 Transducer Summary

This display is only shown if the Transducer option has been enabled.

For further details see the 3500 Engineering Manual HA027988.

On the Transducer Summary page the following parameters are available if 'Calibration Enable' has been set to 'Yes' in configuration level:-



Para Name	Parameter Description	Value		Default	Availability
Start Tare	Set to 'Yes' to automatically calculate tare weight	No/Yes		No	Lev1 or 2
Start Cal	Starts the calibration process. For Load Cell or Comparison calibration 'Start Cal' starts the first calibration point	No Yes	Start calibration	No	Lev1 or 2
Start Hi Cal	For Load Cell or Comparison calibration this starts the second calibration point.	No Yes	Start high calibration	No	Lev1 or 2
Cal Status	Indicates the progress of calibration	Idle	No calibration in progress		Lev 1 or 2 Read only
		Active	Calibration in progress		
		Passed	Calibration good		
		Failed	Calibration bad		
Clear Cal	Clears the current calibration	No Yes	Delete previous cal. values	No	Lev 2
Scale Hi	Sets the scaling output high point. Usually the same as 'Input Hi'	Between Scale Lo and maximum display			Lev 2
Scale Lo	Sets the scaling output low point. Usually 80% of 'Input Lo'	Between Scale Hi and min display			Lev 2
Input Hi	Sets the scaling input high point	Between Input Lo and max display			Lev 2
Input Lo	Sets the scaling input low point	Between Input Lo and min display			Lev 2

Further customised pages may be available if they have been configured.

4. Chapter 4 Safety and EMC Information

This controller is manufactured in the UK by Eurotherm Ltd.

Please read this section carefully before installing the controller

This controller is intended for industrial temperature and process control applications when it will meet the requirements of the European Directives on Safety and EMC. If the instrument is used in a manner not specified in this manual, the safety or EMC protection provided by the instrument may be impaired. The installer must ensure the safety and EMC of any particular installation.

4.1 GENERAL

The information contained in this manual is subject to change without notice. While every effort has been made to ensure the accuracy of the information, your supplier shall not be held liable for errors contained herein.

4.1.1 Safety

This controller complies with the European Low Voltage Directive 73/23/EEC, by the application of the safety standard EN 61010.

4.1.2 Electromagnetic compatibility

This controller conforms with the essential protection requirements of the EMC Directive 89/336/EEC, by the application of appropriate product specific international standards. This instrument satisfies the general requirements of the commercial and industrial environments defined in EN 61326. For more information on product compliance refer to the Technical Construction File.

4.1.3 Unpacking and storage

The packaging should contain an instrument mounted in its sleeve, two mounting brackets for panel installation and an Installation & Operating guide. Certain ranges are supplied with an input adapter.

If on receipt, the packaging or the instrument are damaged, do not install the product but contact your supplier. If the instrument is to be stored before use, protect from humidity and dust in an ambient temperature range of -10°C to +70°C.

4.2 Service and repair

This controller has no user serviceable parts. Contact your supplier for repair.

4.2.1 **Caution: Charged capacitors**

Before removing an instrument from its sleeve, disconnect the supply and wait at least two minutes to allow capacitors to discharge. It may be convenient to partially withdraw the instrument from the sleeve, then pause before completing the removal. In any case, avoid touching the exposed electronics of an instrument when withdrawing it from the sleeve.

Failure to observe these precautions may cause damage to components of the instrument or some discomfort to the user.

4.2.2 Electrostatic discharge precautions

When the controller is removed from its sleeve, some of the exposed electronic components are vulnerable to damage by electrostatic discharge from someone handling the controller. To avoid this, before handling the unplugged controller discharge yourself to ground.

4.2.3 Cleaning

Do not use water or water based products to clean labels or they will become illegible. Isopropyl alcohol may be used to clean labels. A mild soap solution may be used to clean other exterior surfaces of the product.

4.3 Installation Safety Requirements

4.3.1 Safety Symbols

Various symbols are used on the instrument, they have the following meaning:



Caution (refer to the accompanying documents



Protective Conductor Terminal

4.3.2 Personnel

Installation must only be carried out by suitably qualified personnel.

4.3.3 Enclosure of live parts

To prevent hands or metal tools touching parts that may be electrically live, the controller must be installed in an enclosure.

4.3.4 **Caution: Live sensors**

The controller is designed to operate with the temperature sensor connected directly to an electrical heating element. However, you must ensure that service personnel do not touch connections to these inputs while they are live. With a live sensor, all cables, connectors and switches for connecting the sensor must be mains rated.

The logic IO is not isolated from the PV inputs and all cables, connectors and switches for connecting the sensor must be mains rated.

4.3.5 Wiring

It is important to connect the controller in accordance with the wiring data given in this guide. Take particular care not to connect AC supplies to the low voltage sensor input or other low level inputs and outputs. Only use copper conductors for connections (except thermocouple inputs) and ensure that the wiring of installations comply with all local wiring regulations. For example in the UK use the latest version of the IEE wiring regulations, (BS7671). In the USA use NEC Class 1 wiring methods.

4.3.6 Power Isolation

The installation must include a power isolating switch or circuit breaker. The device should be mounted in close proximity to the controller, within easy reach of the operator and marked as the disconnecting device for the instrument.

4.3.7 Overcurrent protection

The power supply to the system should be fused appropriately to protect the cabling to the units.

4.3.8 Voltage rating

The maximum continuous voltage applied between any of the following terminals must not exceed 264Vac:

- relay output to logic, dc or sensor connections;
- any connection to ground.

The controller must not be wired to a three phase supply with an unearthed star connection. Under fault conditions such a supply could rise above 264Vac with respect to ground and the product would not be safe.

4.3.9 Conductive pollution

Electrically conductive pollution must be excluded from the cabinet in which the controller is mounted. For example, carbon dust is a form of electrically conductive pollution. To secure a suitable atmosphere, install an air filter to the air intake of the cabinet. Where condensation is likely, for example at low temperatures, include a thermostatically controlled heater in the cabinet.

This product has been designed to conform to BSEN61010 installation category II, pollution degree 2. These are defined as follows:-

4.3.10 Installation Category II

The rated impulse voltage for equipment on nominal 230V supply is 2500V.

4.3.10.1 Pollution Degree 2

Normally only non conductive pollution occurs. Occasionally, however, a temporary conductivity caused by condensation shall be expected.

4.3.11 Grounding of the Temperature Sensor Shield

In some installations it is common practice to replace the temperature sensor while the controller is still powered up. Under these conditions, as additional protection against electric shock, we recommend that the shield of the temperature sensor is grounded. Do not rely on grounding through the framework of the machine.

4.3.12 Over-Temperature Protection

When designing any control system it is essential to consider what will happen if any part of the system should fail. In temperature control applications the primary danger is that the heating will remain constantly on. Apart from spoiling the product, this could damage any process machinery being controlled, or even cause a fire.

Reasons why the heating might remain constantly on include:

- the temperature sensor becoming detached from the process
- thermocouple wiring becoming short circuit;
- the controller failing with its heating output constantly on
- an external valve or contactor sticking in the heating condition
- the controller setpoint set too high.

Where damage or injury is possible, we recommend fitting a separate over-temperature protection unit, with an independent temperature sensor, which will isolate the heating circuit.

Please note that the alarm relays within the controller will not give protection under all failure conditions.

4.4 Installation Requirements for EMC

To ensure compliance with the European EMC directive certain installation precautions are necessary as follows:

- For general guidance refer to EMC Installation Guide, HA025464.
- When using relay outputs it may be necessary to fit a filter suitable for suppressing the conducted emissions. The filter requirements will depend on the type of load. For typical applications we recommend Schaffner FN321 or FN612.
- If the unit is used in table top equipment which is plugged into a standard power socket, then it is likely that compliance to the commercial and light industrial emissions standard is required. In this case to meet the conducted emissions requirement, a suitable mains filter should be installed. We recommend Schaffner types FN321 and FN612.

4.4.1 Routing of wires

To minimise the pick-up of electrical noise, the low voltage DC connections and the sensor input wiring should be routed away from high-current power cables. Where it is impractical to do this, use shielded cables with the shield grounded at both ends. In general keep cable lengths to a minimum.

5. Chapter 5 Technical Specification

All figures quoted at an ambient temperature from 0 to 50°C unless otherwise stated.

5.1 Control Options

No. of Loops	2
Control Loops	On/Off, single PID
Control Outputs	Analogue, Time proportioned or Motorised Valve control with or without feedback.
Cooling Algorithms	Linear, Water, Fan, Oil
Auto/Manual Control	Bumpless transfer or forced manual output.
Setpoint rate Limit	Off to 9999.9 engineering units per minute
Motorised Valve Control	Valve Position bounded or unbounded. Individual Valve Positions for heat and cool
Tuning	One-shot Auto tune or Manual.
Loop Alarms	High absolute, Low absolute, Deviation high, Deviation low, Deviation band, All with separate hysteresis.
Application Specific	Humidity control, carbon potential

5.2 Display

3504	Primary Large 5 digit display, Information centre 16 character header and 3 lines of 20 characters
3508	Primary Large 4 1/2 digit display, Information centre 8 character header and 3 lines of 10 characters
Technology	LCD with yellow/green backlight Red alarm beacon

5.3 Standard Digital I/O

Allocation	2 Off. Not isolated from each other. Not isolated from the PV inputs Logic Bi-directional input/outputs Logic or Contact closure input
Digital inputs	Voltage level: input Inactive 0 to 7.3Vdc, Active 10.8V to 24Vdc Contact closure: input active <480ohms, inactive >1200ohms
Digital outputs	18Vdc at 15mA drive capability, 9mA minimum
Changeover relay	Contact rating Min Load 1mA at 1V Max Load 2A at 264Vac resistive 1,000,000 operations with addition of external snubber

5.4 All Analogue and PV Inputs

Sample rate	9Hz (110msec.)
Input filtering	OFF to 999.9 seconds of filter time constant (f.t.c.). Default setting is 1.6 seconds
User calibration	Both the user calibration and a transducer scaling can be applied.
Sensor break	a.c. sensor break on each input (i.e. fast responding and no dc errors with high impedance sources).
Ranges	mV, mA, volts -2V to +10V, -1V to +2V or RTD (pt100), pyrometer inputs
Thermocouple types	Most linearisations including K, J, T, R, B, S, N, L, PII, C, D, E with linearisation error < $\pm 0.2^{\circ}\text{C}$
CJC	Automatic (internal), external, 0°C, 45°C, 50°C reference blocks
General	Resolution (noise free) is quoted as a typical figure with input filter set to the default value = 1.6 second. Resolution generally improves by a factor of two with every quadrupling of filter time constant Calibration is quoted as offset error + percentage error of absolute reading at ambient temperature of 25°C Drift is quoted as extra offset and absolute reading errors per degree of ambient change from 25°C.

5.5 PV Input

Accuracy	$\pm 0.1\%$ ± 1 lsd	
Sample rate	9Hz	
Input filter	Off, 0.2s to 60s filter time constant. default setting 1.6s.	
40mV Range	Range	-40mV to +40mV
	Resolution	1.9 μ V (unfiltered)
	Measurement noise	1.0 μ V peak to peak with 1.6s input filter
	Linearity error	0.003% (best fit straight line)
	Calibration error	$\pm 4.6\mu$ V $\pm 0.053\%$ of measurement, at 25C ambient.
	Temperature coefficient	$\pm 0.2\mu$ V/C ± 28 ppm/C of measurement, from 25C ambient.
	Input leakage current	± 14 nA
	Input resistance	100M Ω
80mV Range	Range	-80mV to +80mV
	Resolution	3.2 μ V
	Measurement noise	3.3 μ V peak to peak with 1.6s input filter.
	Linearity error	0.003% (best fit straight line)
	Calibration error	$\pm 7.5\mu$ V $\pm 0.052\%$ of measurement, at 25C ambient.
	Temperature coefficient	$\pm 0.2\mu$ V/C ± 28 ppm/C of measurement, from 25C
	Input leakage current	± 14 nA
	Input resistance	100M Ω
2V Range	Range	-1.4V to +2.0V
	Resolution	82 μ V
	Measurement noise	90 μ V peak to peak with 1.6s input filter
	Linearity error	0.015% (best fit straight line)
	Calibration error	$\pm 420\mu$ V $\pm 0.044\%$ of measurement, at 25C ambient.

	Temperature coefficient	$\pm 125\mu\text{V}/\text{C}$ $\pm 28\text{ppm}/\text{C}$ of measurement, from 25C ambient.
	Input leakage current	$\pm 14\text{nA}$
	Input resistance	100M Ω
10V Range	Range	-3.0V to +10V
	Resolution	500 μV
	Measurement noise	550 μV peak to peak with 1.6s input filter.
	Linearity error	0.007% for zero source resistance (best fit straight line) Add 0.003% for each 10 Ω of source + lead resistance
	Calibration error	$\pm 1.5\text{mV}$ $\pm 0.063\%$ of measurement, at 25C ambient.
	Temperature coefficient	$\pm 66\mu\text{V}/\text{C}$ $\pm 60\text{ppm}/\text{C}$ of measurement, from 25C ambient.
	Input resistance	62.5k Ω to 667k Ω depending on input voltage.
PT100	Range	0 to 400 Ω (-200C to +850C)
	Resolution	50mC
	Measurement noise	50mC peak to peak with 1.6s input filter.
	Linearity error	0.033% (best fit straight line)
	Calibration error	$\pm 310\text{mC}$ $\pm 0.023\%$ of measurement in C, at 25C ambient.
	Temperature coefficient	$\pm 10\text{mC}/\text{C}$ $\pm 25\text{ppm}/\text{C}$ of measurement in C, from 25C ambient.
	Lead Resistance	0 Ω to 22 Ω , matched lead resistances
	Bulb current	200 μA
Thermocouple	Uses 40mV and 80mV ranges	
	Types	J, K, L, R, B, N, T, S, PL2 and C
	Linearisation error	$\pm 0.2\text{C}$
	Internal Cold Junction	Calibration error $\pm 1.0\text{C}$ at 25C ambient. Ambient rejection ratio 40:1 from 25C ambient.
	External Cold Junction	0C, 45C and 50C.

5.6 Analogue Input Module

mV input	100mV range - used for thermocouple, linear mV source, or 0-20mA with 2.49Ω external burden resistor. Calibration: $\pm 10\mu\text{V} + 0.2\%$ of reading Resolution: 6μV Drift: $< +0.2\mu\text{V} + 0.004\%$ of reading per °C Input impedance: $>10\text{M}\Omega$, Leakage: $<10\text{nA}$
0 - 2Vdc input	-0.2V to +2.0V range - used for zirconia. Calibration: $\pm 2\text{mV} + 0.2\%$ of reading Resolution: 30μV Drift: $< \pm 0.1\text{mV} + 0.004\%$ of reading per °C Input impedance: $>10\text{M}\Omega$, Leakage: $<20\text{nA}$
0 - 10Vdc input	-3V to +10.0V range - used for voltage input. Calibration: $\pm 2\text{mV} + 0.2\%$ of reading Resolution: 200μV Drift: $< \pm 0.1\text{mV} + 0.02\%$ of reading per °C Input impedance: $>69\text{K}\Omega$
Pt100 input	0 to 400ohms (-200°C to +850°C), 3 matched wires - up to 22Ω in each lead without errors. Calibration: $\pm(0.4^\circ\text{C} + 0.15\%$ of reading in °C) Resolution 0.08°C Drift: $< \pm(0.015^\circ\text{C} + 0.005\%$ of reading in °C) per °C Bulb current: 0.3mA.
Thermocouple	Internal compensation: CJC rejection ratio $>25:1$ typical. CJ Temp calibration error $<\pm 2^\circ\text{C}$ at 25° ambient 0°C, 45°C and 50°C external compensation available.

5.7 Digital Input Modules

Module type	Triple contact input, Triple logic input
Contact closure	Active <100ohms, inactive >28kohms
Logic inputs	Current sinking : active 10.8Vdc to 30Vdc at 2.5mA inactive -3 to 5Vdc at <-0.4mA

5.8 Digital Output Modules

Module types	Single relay, dual relay, single triac, dual triac, triple logic module (isolated)
Relay rating	2A, 264Vac resistive (100mA, 12V minimum)
Single Logic drive	12Vdc at 24mA
Triple logic drive	12V at 9mA per output
Triac rating	0.75A, 264Vac resistive

5.9 Analogue Output Modules

Module types	1 channel DC control, 1 channel DC retransmission (5 max.) and dual channel
Range	0-20mA, 0-10Vdc
Resolution	1 part in 10,000 (2,000-noise free) 0.5% accurate for retransmission 1 part in 10,000 2.5% accurate for control

5.10 Transmitter PSU

Transmitter	24Vdc at 20mA
-------------	---------------

5.11 Transducer PSU

Bridge voltage	Software selectable 5 or 10Vdc
Bridge resistance	300Ω to 15KΩ
Internal shunt resistor	30.1KΩ at 0.25%, used for calibration of 350Ω bridge at 80%

5.12 Potentiometer Input

Pot resistance 100Ω to 15KΩ, excitation of 0.5 volts

5.13 Digital communications

Allocation 2 modules fitted in slots H & J (isolated)
Modbus: ElBisynch EIA232, 2 wire or 4 wire EIA485, max baud 19.2KB in H module & 9.6KB in J module
Profibus DP High Speed, EIA485, 1.5Mbaud (**Slot H only**)
Ethernet (Modbus TCP) Modbus TCP at IO Base T - slot H only
DeviceNet Maximum baud rate 500KB - slot H only

5.14 Master communications

Allocation Slot J
Modbus EIA485 4-wire or EIA232
Parameters Single parameter master communications

5.15 Alarms

No of Alarms 8 Analogue, 8 digital. Can be wired to any internal parameter. Sensor break alarms are independent from Analogue Alarms. Digital alarms can be + edge, - edge or edge triggered.
Alarm types Full scale, deviation, sensor break plus application specific
Modes Latching or non-latching, blocking, time delay

5.16 Setpoint programmer

Programmer modes Dual programmer – can be configured as two individual single programmers, synchronised start programmer or synchronise in all segments programmer
Programmer types Time to Target or Ramp Rate
No of programs A maximum of 50 programs. Programs can be given user defined 16 character names
No of segments 500 segments total or 50 maximum per program
Event outputs Up to 8, can be assigned individually to segments or called as part of an event group

5.17 I/O Expander

10 I/O version	4 changeover relays, 6 normally open relay contacts, 10 logic inputs
20 I/O version	4 changeover relays, 16 normally open relay contacts, 20 logic inputs

5.18 Advanced functions

Timers	4, On Pulse, Off delay, one shot and min-On
Totalisers	2, trigger level & reset input
Counters	2, up or down counters
Real time clock	Day of week and time
Application blocks	24 digital operations 24 analogue operations 2 eight input logic operators, 2 eight input analogue operators 16 user values BCD input Customised input linearisations Mathematical Add, Subtract, Multiply, Divide, Constant, Absolute difference, Maximum, Minimum, Sample and Hold, Input 1 to the power of input 2, Square root, Log(10), Ln, 10 to the power of input 1, i.e. to the power of input 1 Logical AND; OR; XOR; Latch; Equal; Not Equal; Greater than; Less than; Greater than or equal to; Less than or equal to. Humidity Wet and dry bulb technique Multi operator block – minimum, maximum, average and sum
Software Tools	iTools Configuration Tool OPC Scope Trending and Data logging iClone Lite Lightweight configuration cloning Graphical Wiring Editor Drag and drop wiring tool, self-documenting View Builder Custom Animation Screens iTools Wizard Question and Answer configuration screens

5.19 General specification

Supply	100 to 240Vac -15%, +10%. 48 to 62Hz. 20 watts max Low voltage supply: 24Vac/dc, -15%, +10%
Inrush Current	High Voltage controller – 30A duration 100µs Low Voltage controller – 15A duration 100µs
Operating ambient	0°C - 50°C (32°F to 131°F) and 5 to 95% RH non condensing
Storage temp	-10°C to +70°C (14°F to 158°F)
Panel sealing	IP65, plug in from front panel
Dimensions and weight	
3504	96H x 96W x 150D (mm) 0.6kg
3508	96H x 48W x 150D (mm) 0.4kg
Electromagnetic compatibility	EN61326-1 Suitable for domestic, commercial and light industrial as well as heavy industrial environments. (Class B emissions, Industrial Environment immunity). With Ethernet or DeviceNet module fitted product is only suitable for industrial environments, (class A emissions).
Safety standards	EN61010, installation category II (voltage transients must not exceed 2.5kV), pollution degree 2.
Atmospheres	Not suitable for use above 2000m or in explosive or corrosive atmospheres

 This controller meets the European directives on safety and EMC

6. Restriction of Hazardous Substances

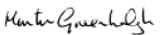
Restriction of Hazardous Substances (RoHS)						
Product group		3500				
Table listing restricted substances						
Chinese						
限制使用材料一览表						
产品	有毒有害物质或元素					
3500	铅	汞	镉	六价铬	多溴联苯	多溴二苯醚
印刷线路板组件	X	O	O	O	O	O
附属物	O	O	O	O	O	O
显示器	O	O	O	O	O	O
模块	X	O	X	O	O	O
O	表示该有毒有害物质在该部件所有均质材料中的含量均在SJ/T11363-2006标准规定的限量要求以下。					
X	表示该有毒有害物质至少在该部件的某一均质材料中的含量超出SJ/T11363-2006标准规定的限量要求。					
English						
Restricted Materials Table						
Product	Toxic and hazardous substances and elements					
3500	Pb	Hg	Cd	Cr(VI)	PBB	PBDE
PCBA	X	O	O	O	O	O
Enclosure	O	O	O	O	O	O
Display	O	O	O	O	O	O
Modules	X	O	X	O	O	O
O	Indicates that this toxic or hazardous substance contained in all of the homogeneous materials for this part is below the limit requirement in SJ/T11363-2006.					
X	Indicates that this toxic or hazardous substance contained in at least one of the homogeneous materials used for this part is above the limit requirement in SJ/T11363-2006.					
Approval						
Name:	Position:	Signature:	Date:			
Martin Greenhalgh	Quality Manager		29/12/2007			

