



Shower drainage with style

Bathroom drains | Shower channels |
Wall drains | Collection 2017







Barrier-free bathroom draining

Bathroom drains | Shower channels | Wall drains

Lifestyle, relaxation, water, individuality are all themes that are integrated into today's modern bathroom design.

Designer faucets, sinks, shower heads and tiles all play a role in planning a top notch bathroom. Finally, to complete this package, KESSEL has brought to the market a new line of a architecturally designed and German engineered shower drains and channels offering previously unavailable choices.

So, the slate is clean. Let your fantasy and creative mind guide you through the planning of your dream bathroom as KESSEL introduces the bathroom drain collection.



■ Bathroom drains with Design covers

*Kessel
Spot*

*Slot
Sticks*

*Festival
Parade*

*Oval
Cross*

Invisible

Gems for your bathroom





■ **Linearis Compact/Comfort shower channels**

Stainless steel cover can be turned and tiled

■ **Scada wall drains** with or without LED lights

Stainless steel cover

Invisible cover

Wave cover

Design brought to the point

Design covers for bathroom drains 06 – 07

Design right down the line

Linearis Compact shower channel 08 – 09

Linearis Comfort shower channel 10 – 11

Design for demanding applications

Scada wall drain 12 – 13

Product overview

Bathroom drains with design covers/drains – advantages, system overview 14 – 15

Linearis shower channels – advantages, system overview 16 – 19

Scada wall drains 20 – 21

Quality from tradition 23



■ An award winning design in an elegant look. Manufactured from high grade stainless steel:



Kessel



Oval



Spot



Cross



Festival



Parade



Slot



Sticks



Invisible

Design brought to the point

Design covers for bathroom drains

Alongside the award winning design, **KESSEL** products are manufactured to the highest standards and are also engineered to perform their intended task, flawless drainage. These aspects have made the **KESSEL** collection the top choice for bathrooms, showers, spas and fitness centers in private, commercial and public areas for the new construction and renovation markets.

Design covers for bathroom drains





- High quality stainless steel cover and rim

- Reverse side of channel cover is recessed for floor tile / natural stone insertion

- Elegant and modern design

In the mood for more options

***Linearis Compact* shower channel**

Shower channels in a classic, timeless design. Minimalistic impression fits elegantly in a purist bathroom design. The finely finished channel surface and perimeter stainless steel frame result in a visual interplay between the shimmering matt and glossy surfaces. Most importantly the center channel can be installed with the stainless steel surface facing up, or reversed to offer a recessed side where the bathroom tile or natural stone surface can be installed. Two very different visual options, all in the same shower channel.





■ Creative variations for your personal space



Stainless steel



Tiled

Natural feeling of comfort

Linearis Comfort shower channel

Sensually calm. Warm ambiance. A feeling of well-being in tune with nature. The natural wood design options play to this style and can provide either a contrasting or harmonious design element.

The vertical adjustability of these shower channels make them ideal for use with custom floor surfaces with different thicknesses such as granite, marble or designer floor tiles. The stainless steel center channel can be reversed and tiled for a seamless integration into the complete bathroom design.





- Choice of four design covers – each of them can be combined with LED lights for a special atmosphere. With automatic colour changing or selection option of specific light colour.



Design for demanding applications

Scada wall drain

The **Scada** wall drain offers completely new design possibilities for barrier-free bathrooms. There is a choice of four different drain covers all made of stainless steel: two are in a smooth finish for different tile thicknesses, one is an almost invisible cover which can be tiled over, and the fourth is in a unique and innovative wave-look design.

As a unique highlight, all the covers are also offered with soothing LED backlighting strips with color changing and selection option of specific light color.





- **Multistop** odour, foam, rodent and insect stop
- Fire-protection insert **Fire-Kit** with vertical outlet and odour trap for drain bodies *Ecoguss* and *Practicus*

- **Lock & Lift** system: Locking and removal device at the same time
- Removable hair filter

- Upper sections can be twisted, tilted and height-adjusted
- Shallow bed upper sections can also be moved for adaptation to the tile pattern

Bathroom drains

Advantages at a glance, system overview

Combination possibilities design and technology

A large selection of design covers including drain bodies, waterproof sealing flanges and accessories. On the right you will find an overview of the combination possibilities for the **KESSEL** upper sections combined with **KESSEL** drain bodies.

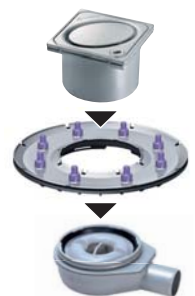

KESSEL upper section with design cover

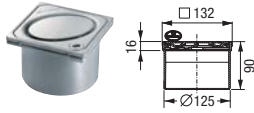

1 Upper section made of ABS, frame □ 132 mm

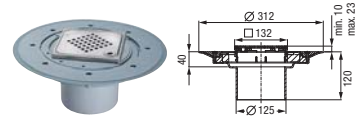

2 Variotfix shallow bed upper section made of ABS, frame □ 132 mm flange Ø 312 mm

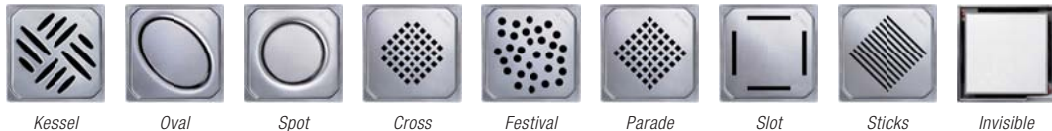

	Kessel	Oval	Spot	Cross	Festival	Parade	Slot	Sticks	Invisible
1 with Lock & Lift	48 201	48 202	48 221	48 213	48 215	48 224	48 219	48 217	48 211
without Lock & Lift	48 225	48 226	48 220	48 212	48 214	48 223	48 218	48 216	-
2 with Lock & Lift	48 904	48 905	48 621	48 613	48 615	48 624	48 619	48 617	48 906
without Lock & Lift	48 625	48 626	48 620	48 612	48 614	48 623	48 618	48 616	-

Accessories



Multistop
odour, foam, rodent and insect stop
48 500



Hair filter
made of polymer
48 700



Glue flange
made of ABS with counter flange,
Ø 348 mm (also for composite seal)
48 410
Note: can be combined with drain bodies and extension sections 48 989, 48 987



Pressure sealing flange
made of stainless steel Ø 273 mm
48 402
Note: can be combined with drain bodies and extension sections 48 989, 48 987



Fire-protection insert Fire-Kit
Only for Ecoguss / Practicus drains with vertical outlet and odour trap
Ø 58/78/83 or 50/75 48 099
Ø 110 48 100
with approval Z-19.17-1719



Quick-Fit the passage seal
for core drillings, for Ecoguss / Practicus drain bodies with vertical outlet
• with fire protection¹⁾ 48 990
with approval Z-19.17-1719
• without fire protection 48 991

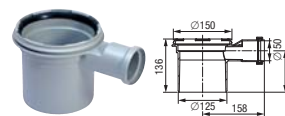

Extension section
made of PP with lip seal
• with inlet 48 989
• without inlet 48 987

Drain bodies

^{*)} according to EN 1253-1 (20 mm threshold)

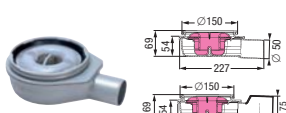

« The Ultraflat » made of ABS
1,0 l/sec flow rate*, with odour trap, sealing water height 30 mm
Lateral outlet Ø 50 45 700
Lateral outlet Ø 75 45 770

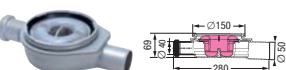

with lateral inlet Ø 40,
lateral outlet Ø 50 45 701

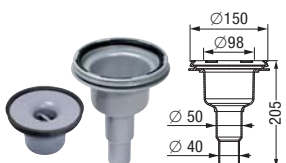

« The Vertical » made of ABS
Vertical outlet Ø 50/40
1,2 l/sec flow rate* with odour trap for fitting in upper section sealing water height 50 mm
45 254



Ecoguss
with odour trap 1,8 l/sec flow rate*, sealing water height 50 mm

Ø	Lateral outlet	Vertical outlet
58	48 358	48 458
78	48 378	48 478
83	48 383	48 483
110	48 311	48 411

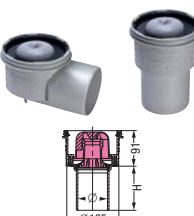

Practicus made of PP,
with odour trap 1,8 l/sec flow rate*, sealing water height 50 mm

Ø	Lateral outlet	Vertical outlet
50	45 150	45 250
75	45 170	45 270
110	45 110	45 210

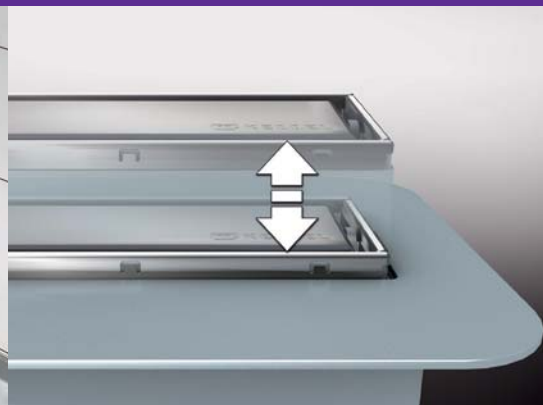

- Complete channels with integrated drain body – compact design for minimum installation depth e.g. **Linearis Compact** installation depth flange only 65 mm
- Easy cleaning and care. Removable channel cover, odour trap and hair filter – exemplary hygiene in the shower area
- Height of frame and cover can also be adjusted. Channel frame can be adjusted to covering thickness of up to 22 mm **Linearis Comfort**

Shower channels

Advantages at a glance, system overviews

Individuality right down the line

The following pages offer an overview of KESSEL shower channels. Page 17 showing the complete drainage channels followed by pages 18 and 19 which display the available combinations and the optional accessories from KESSEL.



KESSEL shower channels *Linearis Comfort*

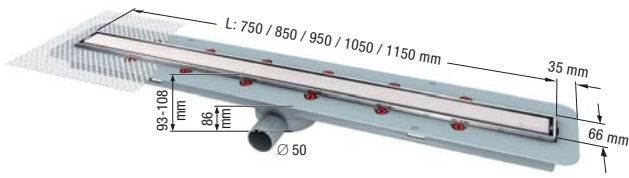

Linearis Comfort shower channel

with drain body, lateral outlet \varnothing 50, with odour trap, sealing water height 22 mm

- **Stainless steel cover**

1,0 l/sec flow rate without threshold, 1,1 l/sec flow rate with 10 mm threshold

Covers	750 mm	850 mm	950 mm	1050 mm	1150 mm
Stainless steel *	45 600.83	45 600.84	45 600.85	45 600.86	45 600.87

*) Stainless steel rim can be turned and tiled

KESSEL shower channels *Linearis Compact*

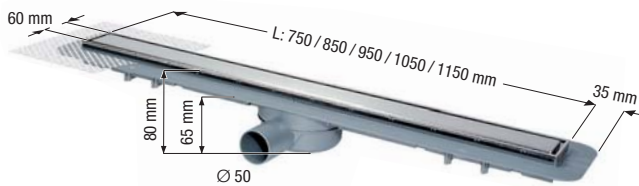

Linearis Compact shower channel

with drain body, lateral outlet \varnothing 50, with odour trap, sealing water height 22 mm

- **Stainless steel cover**

0,5 l/sec flow rate without threshold, 0,6 l/sec flow rate with 10 mm threshold

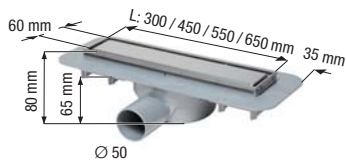

Covers	300 mm	450 mm	550 mm	650 mm	750 mm
Stainless steel *	45 600.59	45 600.60	45 600.61	45 600.62	45 600.63
	850 mm	950 mm	1050 mm	1150 mm	
	45 600.64	45 600.65	45 600.66	45 600.67	

*) Stainless steel rim can be turned and tiled

Accessories



Multistop

odour, foam, rodent and insect stop
48 400

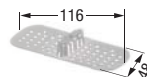

Hair filter

made of polymer
48 800



Installation aid

used instead of lining with screed
Linearis Comfort 48 640
Linearis Compact 48 639

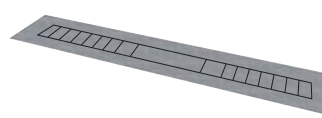

Waterproofing seal

can be shortened to match the channel length
48 638

KESSEL shower channels upper sections *Linearis Comfort*

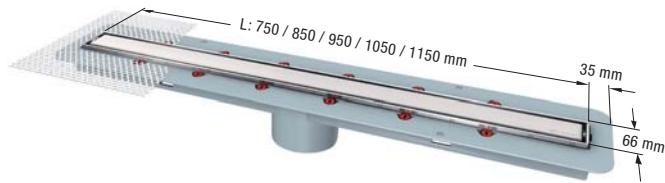

Shower channel upper section *Linearis Comfort* with odour trap, sealing water height 50 mm

- Stainless steel cover

1,0 l/sec flow rate without threshold, 1,1 l/sec flow rate with 10 mm threshold

Covers	750 mm	850 mm	950 mm	1050 mm	1150 mm
Stainless steel *	48 928 S	48 929 S	48 930 S	48 931 S	48 932 S

*) Stainless steel rim can be turned and tiled

Accessories



Multistop

odour, foam, rodent and insect stop
48 400

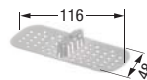

Hair filter

made of polymer
48 800



Installation aid

used instead of lining with screed
48 640

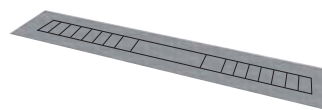

Waterproofing seal

can be shortened to match the channel length
48 638



Glue flange

made of ABS with counter flange, Ø 348 mm (also for composite seal)
48 410



Quick-Fit the passage seal

for core drillings, for *Ecoguss / Practicus* drain bodies with vertical outlet

- with fire protection¹⁾ 48 990 with approval Z-19.17-1719

- without fire protection 48 991



Pressure sealing flange

made of stainless steel Ø 273 mm
48 402

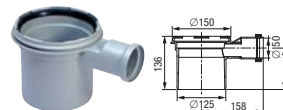

Extension section

made of PP with lip seal

- with inlet 48 989
- without inlet 48 987

Drain bodies

The *Linearis Comfort* shower channel inserts already include an odour trap. For this reason, the odour trap must be removed from the drain body during installation.

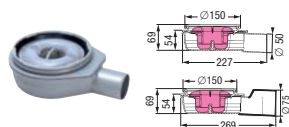

« The Ultraflat » made of ABS

1,0 l/sec flow rate*, with odour trap, sealing water height 30 mm

Lateral outlet Ø 50 45 700
Lateral outlet Ø 75 45 770



with lateral inlet Ø 40,

lateral outlet Ø 50 45 701



Ecoguss

with odour trap 1,8 l/sec flow rate*, sealing water height 50 mm

Ø	Lateral outlet	Vertical outlet
58	48 358	48 458
78	48 378	48 478
83	48 383	48 483
110	48 311	48 411

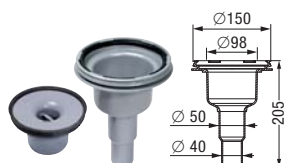

« The Vertical » made of ABS

Vertical outlet Ø 50/40

1,2 l/sec flow rate* with odour trap for fitting in upper section sealing water height 50 mm

45 254



Practicus made of PP,

with odour trap 1,8 l/sec flow rate*, sealing water height 50 mm

Ø	Lateral outlet	Vertical outlet
50	45 150	45 250
75	45 170	45 270
110	45 110	45 210

KESSEL shower channels upper sections *Linearis Compact* and upper sections with design covers



Shower channel upper section *Linearis Compact*
with removable odour trap, sealing water height 50 mm
• **Stainless steel cover**
0,6 l/sec flow rate with 10 mm threshold

Covers	750 mm
Stainless steel *	47 808S

*) Stainless steel rim can be turned and tiled

Upper section
made of ABS, frame □ 120 mm

<i>Kessel</i>	<i>Oval</i>	<i>Spot</i>	<i>Cross</i>	<i>Festival</i>	<i>Parade</i>	<i>Slot</i>	<i>Sticks</i>	<i>Invisible</i>	
with <i>Lock & Lift</i>	48 201	48 202	48 221	48 213	48 215	48 224	48 219	48 217	48 211
without <i>Lock & Lift</i>	48 225	48 226	48 220	48 212	48 214	48 223	48 218	48 216	-

Accessories

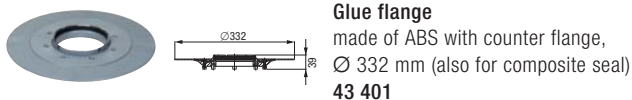

Glue flange
made of ABS with counter flange,
Ø 332 mm (also for composite seal)
43 401

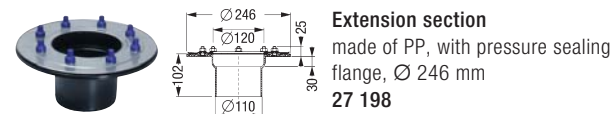

Extension section
made of PP, with pressure sealing
flange, Ø 246 mm
27 198

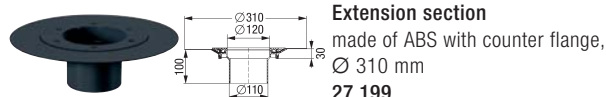

Extension section
made of ABS with counter flange,
Ø 310 mm
27 199

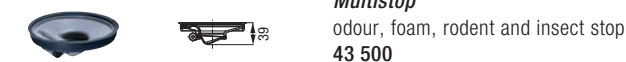

Multistop
odour, foam, rodent and insect stop
43 500

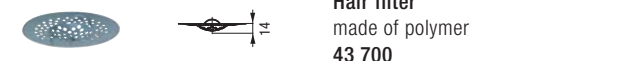

Hair filter
made of polymer
43 700

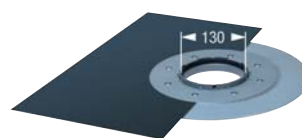

**Glue flange and waterproof
membrane** (made of PVC)
membrane pre-mounted,
1200 x 1200 mm 43 401.91
1800 x 2000 mm 43 401.93
membrane without punched- out hole,
1800 x 2000 mm 43 711

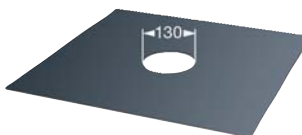

Elastomer waterproof membrane
□ 500 mm
in PVC 43 710
in EPDM 43 730



Extension section
made of PP, with lip seal,
27 146



Transition section
with sealing ring Ø 50
Ø 50/75 27 126
Ø 50/40 27 118

Drain bodies

*) according to EN 1253-1 (20 mm threshold)

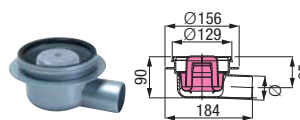

Classic made of ABS
0,8 l/sec flow rate*
sealing water height 50 mm

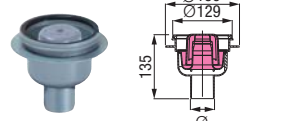

outlet	with odour trap	without odour trap
Lateral	Ø 50 40 150	Ø 50 40 151
	Ø 75 40 170	Ø 75 40 171
Vertical	Ø 50 40 250	Ø 50 40 251
	Ø 75 40 270	Ø 75 40 271



« The Superflat » made of PP
0,8 l/sec flow rate*, with odour trap,
sealing water height 30 mm



Lateral outlet Ø 50	
Without lateral inlet	42 700
One lateral inlet Ø 40	42 701
Three lateral inlets Ø 40	42 703

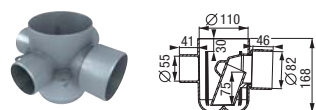

Floordrain ME made of ABS
three lateral inlets Ø 55, one lateral outlet Ø 82, 1,8 l/sec flow rate, with odour trap, glue connection acc. to BS 5255
37 3001
Conversion kits
"DIN push-fit connection" 37 3008 "DIN glue connection" 37 3007

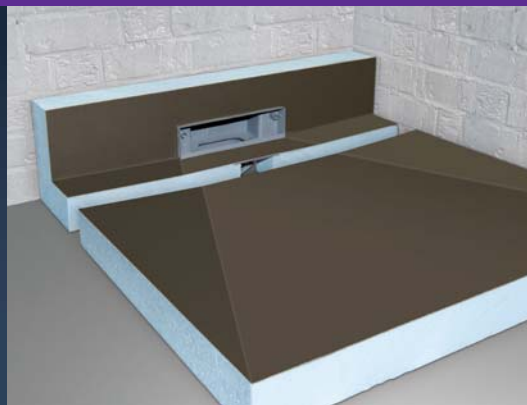

- Adjustable installation supports guarantee straightforward setting of the installation height of only 80 mm up to the top tile edge and individual wall clearances for dry- and wet-wall constructions
- Three installation options for brick and mortar, drywall and also available with the **Scada** wall drain pre-installed in a board with integrated drainage slopes.
- Easy cleaning and maintenance. The drain cover can simply be removed without any tools, the odor trap can then be removed by hand offering full access to the interior of the drain body for cleaning and maintenance purposes.

Wall drains

Advantages at a glance, system overview

Barrier-free creativity

Top material quality as well as convenient installation conditions and flexible connection possibilities are the advantages of the **Scada** wall drain.

Four high-quality drain covers made of stainless steel, one of which can be tiled over, stand for a clear design. A choice of optional LEDs in different colours makes the **Scada** wall drain the highlight of the most modern bathrooms.

KESSEL Scada wall drains without LED lights / with LED lights

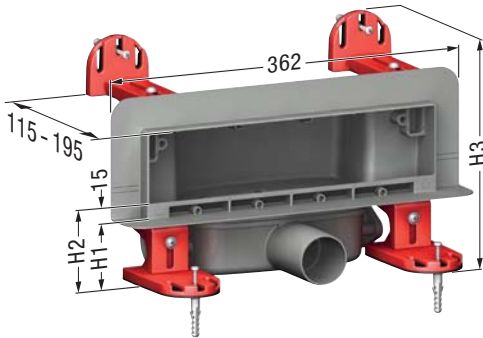

Scada wall drain made of ABS
with a choice of covers with / without LED lights
 with odour trap, sealing water height 22 mm, with flange for alternative sealing,
 Ø 50 outlet (connection possibilities at the front, left or right side)

H1 = Upper edge flange 65 - 200 mm H2 = Upper edge tile 80 - 215 mm H3 = Overall height 218 - 353 mm (incl. installation supports)

Scada invisible cover

can be tiled over with tiles up to 10 mm



W x H 296 x 61 mm for floor tiles up to 10 mm

Scada stainless steel cover



W x H 312 x 74 mm for floor tiles up to 10 mm

Scada Wave cover



W x H 312 x 74 mm for floor tiles up to 10 mm

Scada stainless steel cover



W x H 312 x 67 mm for floor tiles up to 17 mm

Scada drain body and cover

without LED	48 000.01	48 000.02	48 000.03	48 000.04
with RGB LED	48 003.41	48 003.42	48 003.43	48 003.44

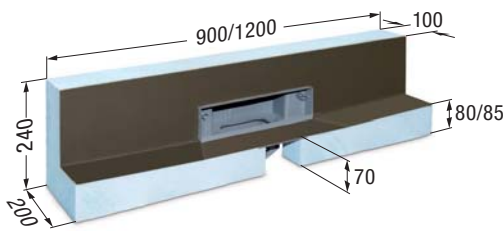

Scada drain body in ① installation board 900 x 200 mm or ② installation board 1200 x 200 mm and drain cover

without LED	① 48 001.01 ② 48 002.01	① 48 001.02 ② 48 002.02	① 48 001.03 ② 48 002.03	① 48 001.04 ② 48 002.04
with RGB LED	① 48 004.41 ② 48 005.41	① 48 004.42 ② 48 005.42	① 48 004.44 ② 48 005.43	① 48 004.44 ② 48 005.44

Accessories



Multistop
 odour, foam, rodent and insect stop
48 400

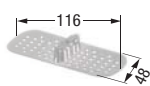

Hair filter
 made of polymer
48 800

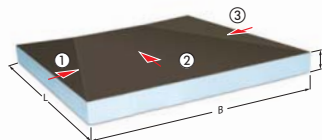

For models with installation board: shower base board with integrated slope
 with integrated 3-sided slope

900 x 900 x 80 mm (L x B x H) **48051**
 Slope: ① 2,4 % ② 0,8 % ③ 2,4 %

1200 x 1200 x 85 mm (L x B x H) **48052**
 Slope: ① 3,7 % ② 1,1 % ③ 3,7 %





Quality from tradition made in Germany

The highest quality standards, attention to detail, drive to perfection and continuous innovation has established KESSEL as one of the worldwide leading manufacturers in the drainage technology field.

Working to these standards and with the most modern technology allowed Kessel to establish a Design Line of drainage products.

These high end products are designed, developed, produced and tested all by KESSEL in our German headquarters - they are truly Made in Germany. These products are not only for private and domestic applications but also ideal for large commercial and public projects as well as renovation work.



Leading in drainage

KESSEL AG

Bahnhofstraße 31 · 85101 Lenting · Germany

www.kessel.com

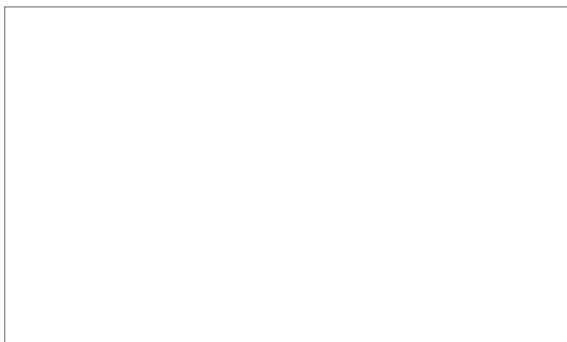

Subject to technical modifications.