



**MANNESMANN
DEMAC**

Material Handling

DST Multi-Button Pendant Switch

Description, Pendant Switch Cpl., Components

1. General

Use

Multi-button pendant switches of the DST type range are manually operated and used for the control of machinery and equipment, preferably for floor control of

hoists and overhead travelling cranes. By fitting different switching elements it is possible to use these switches for direct-on-line control of drive motors with an

output of 3 kW. Motors with a higher output are controlled through auxiliary circuits or contactors.

Design

The following variants of control pendant casings are available:

- DST 3 with 3 openings for switching elements
- DST 6 with 6 openings for switching elements
- DST 7 with 7 openings for switching elements
- DST 9 with 9 openings for switching elements

arranged in one vertical row. The casings are of glass fibre reinforced polyester resin. The upper part of the casing is black (RAL 9005), the lower part yellow (RAL 1007).

The pendant switch casings are ergonomically styled for easy operation, even with gloves, e.g. in plants with a hot atmosphere. The buttons have a large surface and require low operating and holding forces. The holding force to be exercised by the hand when switching is below 8 N and thus in conformity with relevant standards.

The specially angled casing design of the DST control pendant enables operators to work in a natural position thereby reducing fatigue. A spoiler at the lower end of the casing prevents the operator's hand from sliding off.

In the casing, the leads are guided by clips which ensures that any squeezing of leads is impossible when assembling the housing halves.

The normally closed contacts of the switching elements operate automatically and thus fulfil the requirements of a safety switch.

The identification plates underneath the buttons can be fitted without dismantling the switching element. The arrow symbols on the identification plates are those adopted in January, 1965, by Section IX of the FEM (Federation of European Handling Equipment Manufacturers). Colours: black symbol on a yellow background or conversely for the opposite direction.

Standards and codes

The multi-button pendant switches comply with relevant governing international standards.

Material properties

The material of the pendant switch casings is flame and impact resistant and self-extinguishing (according to relevant codes and standards), resistant to corrosion and unaffected by extreme climatic conditions; it is furthermore resistant to

all types of petrol, oil and grease, to salt water, and to diluted acids and alkalines. The materials used are suitable for arduous mechanical and electrical duties. In plants with an acid atmosphere, additional strainer cords must be provided for DST 3 D pendant switches. The maximum permissible temperatures under operating conditions are -25° to +70°C for rubber and thermoplastics and -40°C to +150°C for the casing.

ded for DST 3 D pendant switches. The maximum permissible temperatures under operating conditions are -25° to +70°C for rubber and thermoplastics and -40°C to +150°C for the casing.

Type of enclosure

The control pendant switches ready for operation comply with type of enclosure

IP 65, i.e. dust tight and protection against hose water from all directions.

Protective insulation

High electrical safety due to protective insulation in accordance with relevant

codes and standards.

Cable entrance and strain relief

The standard variant of the pendant switches type DST 3 for direct control is equipped with a high-tensile flexible tube to relieve traction on the control cable. At the same time, the flexible tube protects the control cable fitted inside from mechanical damage. The maximum possible dia. of the cable to be used with such a tube is 16 mm.

For all other pendant switch variants, strain relief is effected by 2 polyamide-sheathed wire ropes. For cable entrance and sealing purposes, these pendant switch variants are equipped with a protective sleeve against kinking which is suitable for outer cable diameters from 10-25 mm. When fitting the control cable, the conical protective sleeve can be

adjusted to outer cable diameters from 10-13, 12-16, 16-19, 19-22, or 22-25 mm, by cutting it off as required. An additional hose clip fitted to the upper end of the protective sleeve presses the latter against the outer sheath of the control cable and thus ensures watertight sealing.

Explanation of type coding

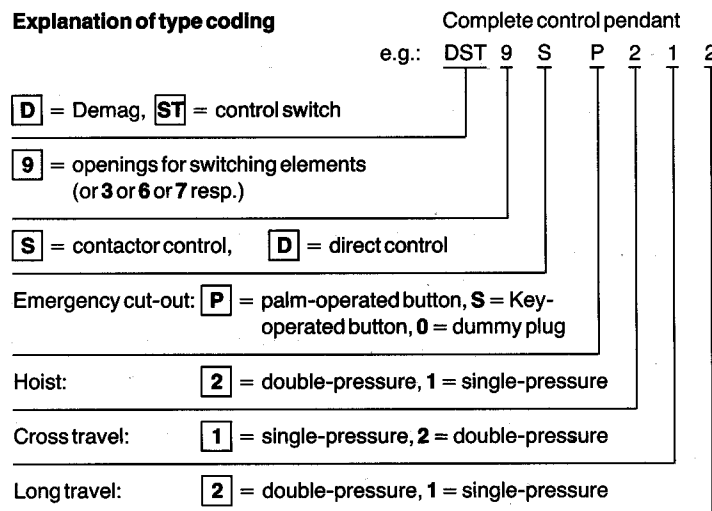

Switching elements

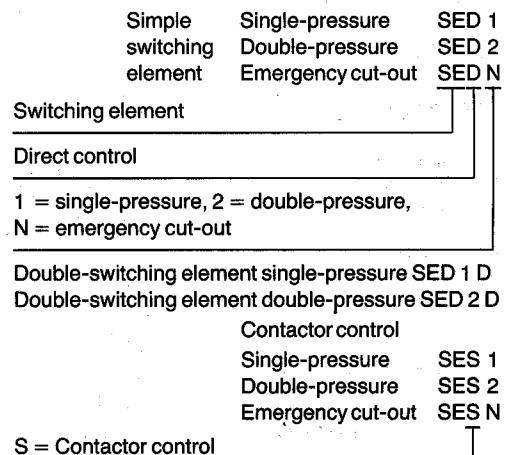

2. Technical Data

Switching elements

Auxiliary-circuit switching element	type	SES 1	SES 2	SES N	SED 1	SED 2	SED N
Main-circuit switching element	type						
Contacts		1NC + 1NO	1NC + 2-step	1NC + 1NO	2NC + 2NO	1st step 2NC + 2NO	3NC
Steps		1	NO 2	1	1	2nd step 2DT	1
Nominal insulation voltage U_i							
Life in terms of switching cycles							
Mechanical	S				up to 2×10^6		
Electrical	S				see diagram 1		
Max. no. of switching cycles	S/h				see diagram 2		
Terminal screws					M3,5		
Connecting lead cross section	mm ²				max. 2×2.5		
Max. nominal current of short-circuit fuse, delayed action	A	16	16		20	20	
Nominal operating current I_e							
40-60 c/s for 220 V	A	10	10	25	10	10	25
380 V	A	6	6	25	6	6	25
415 V	A	5.3	5.3	25	5.3	5.3	25
500 V	A	4.5	4.5	25	4.5	4.5	25
Category ¹⁾		AC11	AC11	AC1	AC4	AC4	AC1
Continuous current I_{th2}	A				25		

Casing

Type of enclosure		IP 65
Electrical safety		Protective insulation according to relevant international standards
Ambient temperature min/max		
Rubber and thermoplastics	°C	-25° to + 70°C
Casing, upper/lower part	°C	-40° to + 150°C
Dia. of opening for switching element	mm	22.5

- ¹⁾ AC 1: Light switching conditions; making: 1.5 x nominal current; breaking: 1 x nominal current
 AC 3: Normal switching conditions; making: up to 6 x nominal motor current; breaking: 1 x nominal motor current
 AC 4: Extreme switching conditions (operational short-impulse switching); making: 6 x nominal motor current; breaking: 6 x nominal motor current
 AC 11: Normal switching conditions; making: 10 x nominal current; breaking: 1 x nominal current

Diagram of operating force (F) as dependent on operating path (S) for single and double-pressure auxiliary and main circuit switching elements

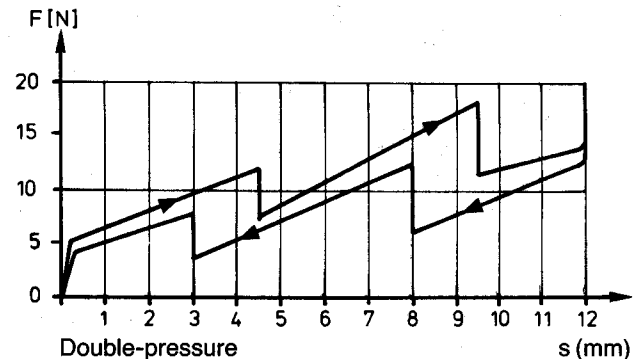
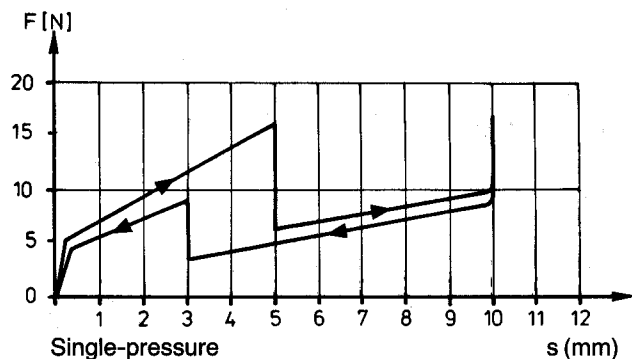

Switch life as dependent on the breaking current

- I_a Breaking current
 S Switching cycles
 I_e Nominal operating current

Approximate values for the max. number of switching cycles per hour (s/h) of the SE switching elements as dependent on the nominal operating current

1 switching cycle =
 1 switching on and 1 switching off operation

Diagram 1

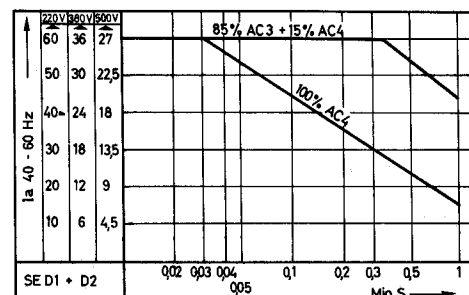
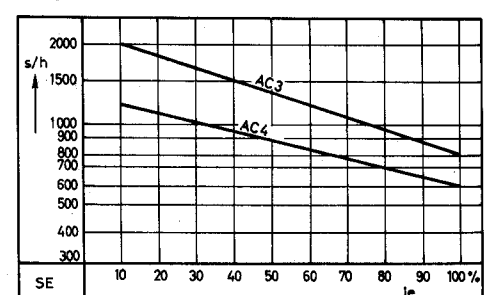

Diagram 2



Standard Control Pendant Switches

Control pendant switch type DST

Standard variant complete for direct control, without control cable, for all drive units, With control cable ¹⁾ for direct control of PK hoists including travel drives.

¹⁾ CSA approval only for detached multi-button pendant switch without control cable.

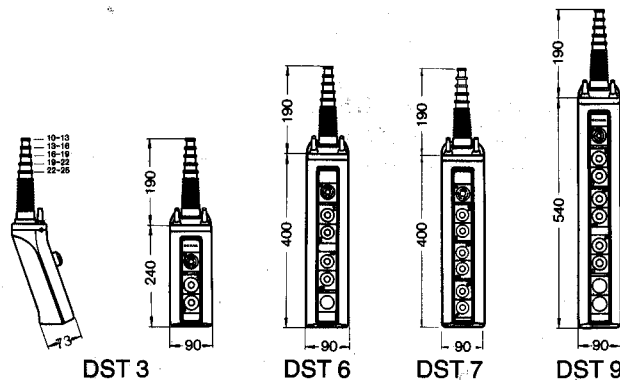

Identification plate	Type	Cable		Part. No.	Switching elements fitted		Weight kg
		m	Leads x mm ²		Qty.	Type	
↕	DST3 DO 1	-	-	874 250 44	1	SED 1 D	1.2
		0.8	4 x 1.5	874 301 44			
		1.8		874 302 44			
		2.8		874 303 44			
		3.8		874 304 44			
		4.8		874 305 44			
6.8	874 306 44						
↕↕	DST3 DO 2	-	-	874 251 44	1	SED 2 D	1.25
		0.8	6 x 1.5	874 308 44			
		1.8		874 309 44			
		2.8		874 310 44			
		3.8		874 311 44			
		4.8		874 312 44			
6.8	874 313 44						
<u>Emergency cut-out</u> ↕	DST3 DP 1	-	-	874 252 44	1 1	SEDN SED 1 D	1.3
		1.8	6 x 1.5	874 316 44			
		2.8		874 317 44			
		4.8		874 319 44			
<u>Emergency cut-out</u> ↕↕	DST3 DP 2	-	-	874 253 44	1 1	SEDN SED 2 D	1.35
		1.8	8 x 1.5	874 323 44			
		2.8		874 324 44			
↕↕↕	DST6 DO 11	-	-	874 260 44	2	SED 1 D	1.9
		0.8	6 x 1.5	874 361 44			
		1.8		874 362 44			
		2.8		874 363 44			
		3.8		874 364 44			
		4.8		874 364 44			
6.8	874 365 44						
<u>Emergency cut-out</u> ↕↕↕	DST6 DP 11	-	-	874 268 44	1 2	SEDN SED 1 D	1.91
		1.8	8 x 1.5	874 375 44			
2.8	874 376 44						
3.8	874 377 44						
4.8	874 378 44						
6.8	874 379 44						
<u>Emergency cut-out</u> ↕↕↕↕	DST6 DP 21	-	-	874 269 44	1 1 1	SEDN SED 2 D SED 1 D	1.91
		1.8	8 x 1.5	874 368 44			
		2.8		874 369 44			
		3.8		874 370 44			
		4.8		874 371 44			
6.8	874 372 44						
↕↕↕↕	DST6 DO 12	-	-	874 261 44	1 1	SED 1 D SED 2 D	1.9
		1.8	8 x 1.5	874 368 44			
		2.8		874 369 44			
		3.8		874 370 44			
		4.8		874 371 44			
		6.8		874 372 44			
↕↕↕↕↕	DST6 DO 22	-	-	874 263 44	2	SED 2 D	1.9
		1.8	10 x 1.5	874 382 44			
		2.8		874 383 44			
		3.8		874 384 44			
		4.8		874 385 44			
		6.8		874 386 44			
<u>Emergency cut-out</u> ↕↕↕↕↕	DST7 DP 111	-	-	874 356 44	1 3	SEDN SED 1 D	2.2
		1.8	-	874 357 44			
2.8	874 357 44						
3.8	874 357 44						
4.8	874 357 44						
6.8	874 357 44						
<u>Emergency cut-out</u> ↕↕↕↕↕↕	DST7 DP 2111	-	-	874 357 44	1 1 2	SEDN SED 2 D SED 1 D	2.2
		1.8	-	874 357 44			
		2.8		874 357 44			

Control pendant switch type DST
 Standard variant complete without
 control cable, for contactor control

Identification plate	Type	Part No.	Switching elements fitted		Weight kg
			Qty.	Type	
	DST3 SO 1	874 254 44	2	SES 1	1.2
	DST3 SO 2	874 255 44	2	SES 2	1.2
<u>Emergency cut-out</u> 	DST3 SP 1	874 258 44	1 2	SESN SES 1	1.3
<u>Emergency cut-out</u> 	DST3 SP 2	874 259 44	1 2	SESN SES 2	1.3
	DST6 SO 11	874 273 44	4	SES 1	1.82
	DST6 SO 21	874 274 44	2 2	SES 2 SES 2	1.82
	DST6 SO 22	874 275 44	4	SES 2	1.82
<u>Emergency cut-out</u> 	DST6 SP 11	874 270 44	1 4	SESN SES 1	1.9
<u>Emergency cut-out</u> 	DST6 SP 21	874 271 44	1 2 2	SESN SES 2 SES 1	1.91
<u>Emergency cut-out</u> 	DST6 SP 22	874 272 44	1 4	SESN SES 2	1.91
<u>Emergency cut-out</u> 	DST7 SP 111	874 352 44	1 6	SESN SES 1	2.1
<u>Emergency cut-out</u> 	DST7 SP 211	874 353 44	1 2 4	SESN SES 2 SES 1	2.1
<u>Emergency cut-out</u> 	DST7 SP 212	874 354 44	1 4 2	SESN SES 2 SES 1	2.1
<u>Emergency cut-out</u> 	DST7 SP 222	874 355 44	1 6	SESN SES 2	2.1
<u>Emergency cut-out</u> 	DST9 SP 111	874 285 44	1 6	SESN SES 1	2.5
<u>Emergency cut-out</u> 	DST9 SP 211	874 268 44	1 2 4	SESN SES 2 SES 1	2.5
<u>Emergency cut-out</u> 	DST9 SP 212	874 287 44	1 4 2	SESN SES 2 SES 1	2.5
<u>Emergency cut-out</u> 	DST9 SP 222	874 288 44	1 6	SESN SES 2	2.5

The above emergency cut-out buttons do not comply with the emergency cut-out switch as defined by Swiss regulations.

Component parts for DST control pendant switch

Switching elements for main current

Type	Description	Part No.	Weight kg	
SED 1	Switching element single-pressure 2 NC + 2 NO	874 200 44	0.097	<p>SED 1</p>
SED 2	Switching element double-pressure 1st stage 2 NC + 2 NO 2nd stage 2 DT	874 201 44	0.122	<p>SED 2</p>
SEDN	Switching element Emergency cut-out ¹⁾ 3 NC	874 203 44	0.090	<p>SEDN</p>
SED 1 D	Double-switching element (2 x SED 1, wired)	874 209 44	0.205	<p>SED 1 D</p>
SED 2 D	Double-switching element (2 x SED 2, wired) Connecting wires for switching elements	874 210 44	0.255	<p>SED 2 D</p>
AWG 16	Thermoplastic-insulated core solid 1.31 ² red for control current (contactor control)	894 493 44	0.02/m	
AWG 16	Thermoplastic-insulated core solid 1.31 ² black for main current (direct control)	894 494 44	0.02/m	

Switching elements for control current

SES 1	Switching element single-pressure 1 NC + 1 NO	874 194 44	0.080	<p>SES 1</p>
SES 2	Switching element double-pressure 1 NC + two 2-step NO	874 195 44	0.085	<p>SES 2</p>
SESN	Switching element Emergency cut-out ¹⁾ 1 NC + 1 NO	874 198 44	0.076	<p>SESN</p>

¹⁾ Can only be fitted in connection with emergency cut-out button 874 212 33.

²⁾ Contact bridges to be fitted only on PK electric chain hoists and on travel drives.

The scope of supply for empty casings includes the completely assembled multi-button pendant switch casing with the exception of switching elements and identification plates, which must be ordered separately. Neoprene and rubber caps for switching elements see below. To ensure correct operation as required, only SED 1 D or SED 2 D double-switching elements may be used for the assembly of empty casings into complete multi-button pendant switches for direct control of the respective drive units.

The scope of supply for SES N 874 199 44 and SED N 874 202 44 switching elements includes 4 each emergency cut-out buttons complete 874 212 44.

Empty casings and switching elements (to be fitted by the customer) in unit packages

Type	Description	Part. No.	Weight kg
DST 3 D	Casing complete with flexible rubber boot (traction relief by flexible tube)	874 190 44	0.730
DST 3 S	Casing complete with protective sleeve against kinking (traction relief by strainer cord 874 299 44)	874 191 44	1.04
DST 6	Casing complete with protective sleeve against kinking	874 192 44	1.5
DST 7	Casing complete with protective sleeve against kinking	874 189 44	1.6
DST 9	Casing complete with protective sleeve against kinking	874 193 44	1.95
SES 1	Switching element (12 units/package)	874 196 44	1.44
SES 2	Switching element (12 units/package)	874 197 44	1.5
SES N	Switching element (4 units/package)	874 199 44	0.53
SED N	Switching element (4 units/package)	874 204 44	0.59
SED 1 D	Switching element (6 units/package)	874 205 44	1.47
SED 2 D	Switching element (6 units/package)	874 206 44	1.77

The scope of supply for empty casings includes the complete multi-button pendant switch with the required switching elements and identification plates fitted. The empty casings are equipped with switching elements (pages 6-7) and identification plates (page 10) as specified by the customer on order form 212 399 44. The prices for the switching elements must be added to the price for the empty casing.

Black neoprene caps, part no. 874 045 44, for service temperatures between -25°C and +75°C, are fitted as standard equipment to switching elements type SE.. or supplied separately when they are to be fitted by the customer.

For service temperatures ranging from -60°C to > +75°C, silicone rubber caps, part no. 874 046 44, must be ordered separately.

Empty casings (switching elements are fitted in the works)

DST 3 D	Casing complete with flexible rubber boot (traction relief by flexible tube)	874 246 44*	
DST 3 S	Casing complete with protective sleeve against kinking (traction relief by strainer cord 874 299 44)	874 247 44*	
DST 6	Casing complete with protective sleeve against kinking	874 248 44*	
DST 7	Casing complete with protective sleeve against kinking	874 245 44*	
DST 9	Casing complete with protective sleeve against kinking	874 249 44*	
DST 12	2 x DST 6 coupled	874 459 44*	
DST 14	2 x DST 7 coupled	874 460 44*	
DST 18	2 x DST 9 coupled	874 461 44*	

* Number only applicable for internal processing.

Note:
Only CSA or UL approved AWG 16 wire with red insulation for contactor or with

black insulation for direct control may be used for wiring the switching elements. For part no. see page 6.

	Type	Designation	Part No.	Weight kg
		Emergency cut-out button with identification plate 874 068 44 cpl. (only in combination with SEDN or SESN switching elements)	874 212 44	0.016
Emergency cut-out button	PS-V/K-NA	Key-operated switch cpl. with switching elements 1 NC + 1 NO, with 2 keys	505 431 44	0.130
	L2-rt/Fa L2-rt/Fb/GI/ 42 V	Signal lamp, red 220 V, 2 W	874 219 44	0.032
		42 V, 2 W	874 218 44	0.032
PS-V/K-NA ³⁾				
	L2-gn/Fa L2-gn/Fb/GI/ 42 V	Signal lamp, green 220 V, 2 W	874 221 44	0.032
		42 V, 2 W	874 220 44	0.032
Signal lamp ³⁾				
	L2-ws/Fa L2-ws/Fb/GI/ 42 V	Signal lamp, white 220 V, 2 W	874 223 44	0.032
		42 V, 2 W	874 222 44	0.032
Signal lamp ³⁾				
	W 3/Ka-NA	Selector switch cpl., 3 notches I-0-II (1 NO each in positions I and II)	504 167 44	0.041
W 3/Ka-NA ³⁾				
	Dd/G/Kd-NA	Double-button ON-OFF ⁵⁾ Dummy plug cpl.	874 215 44	0.052
		black	874 213 44	0.010
		yellow	874 214 44	0.010
Dd/G/Kd-NA ³⁾				
		Sealing ring	874 043 44	0.001
		Traction relief cord, plastic-sheathed steel rope 2.5 dia.	874 299 44	0.017/m
Spacer		Clamping sleeve	871 191 44	0.082
		Spacer for strainer cord ⁴⁾	874 290 44	
		Special flexible tube for DST 3 D (traction relief and protection for control cable, 20 mm inner dia.)	872 242 44	0.27/m
		Threaded bush PG 16 (for securing special tube, e.g. to PK hoist)	872 240 44	0.100

³⁾ Type of enclosure IP 54. IP 65 with sealing ring 874 043 44 below the external ring.

⁴⁾ For cables of up to 4 m in length: 1 off 0.5 m above the multi-button pendant switch and 1 off 0.5 m below the terminal box. For cables of up to 7 m in length: 1 spacer in addition; for cables above 7 m in length: 1 off in addition every 3 m.

⁵⁾ Can only be fitted to: DST 3, opening 1; DST 6, openings 1 and 6; DST 7, opening 1; DST 9, openings 1, 8, and 9 (where openings 8 and 9 are free).

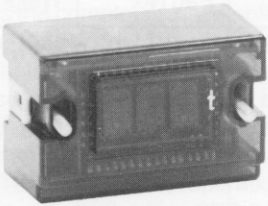
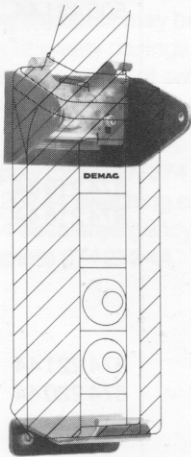
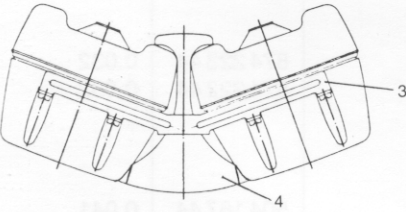
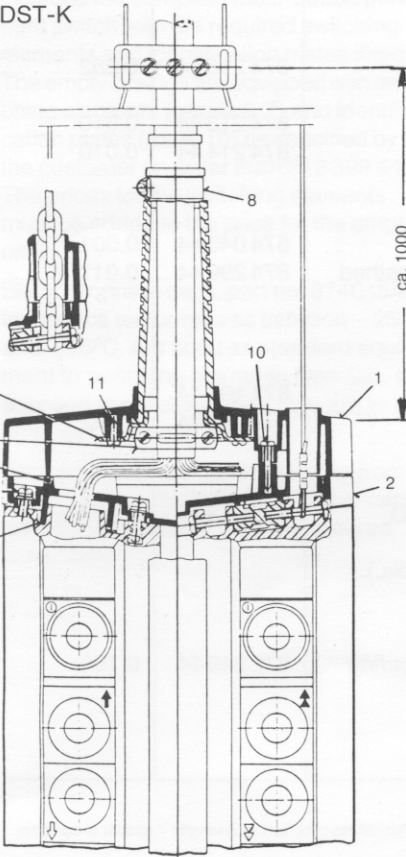
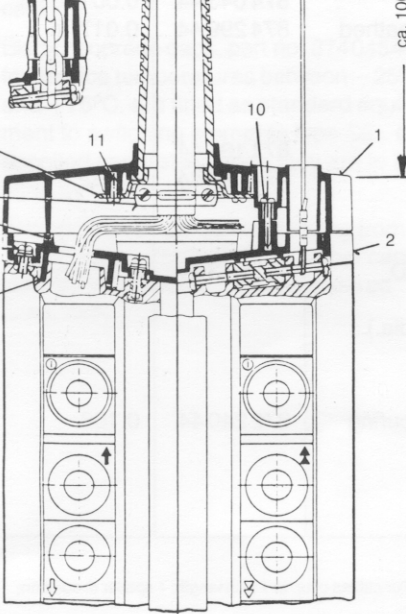
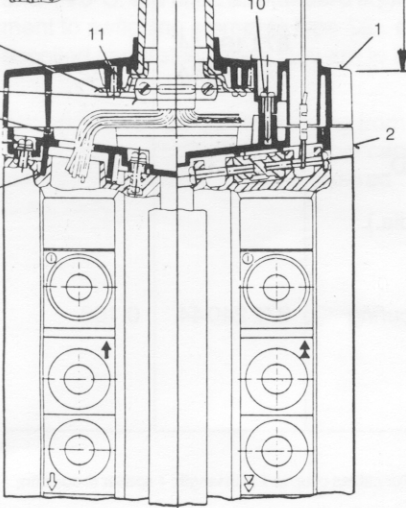
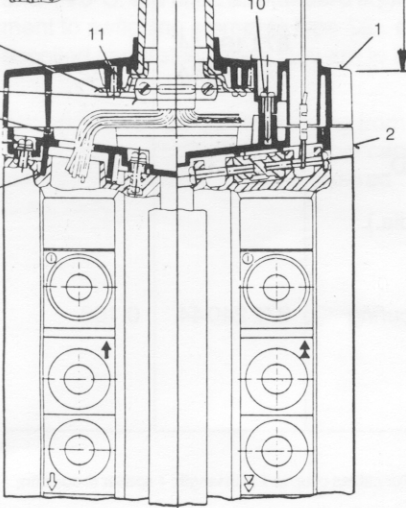
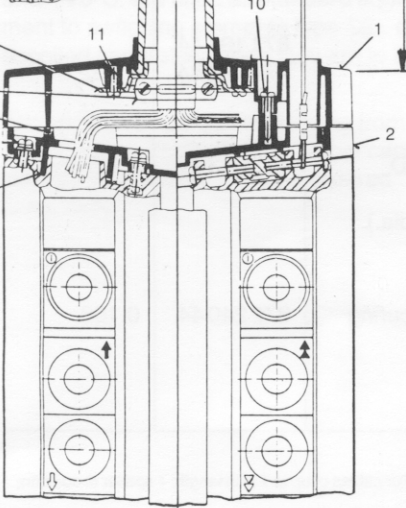
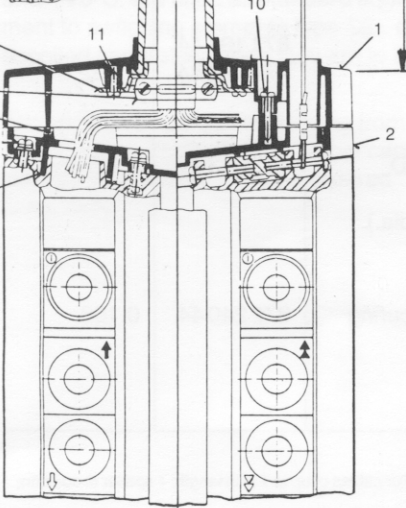
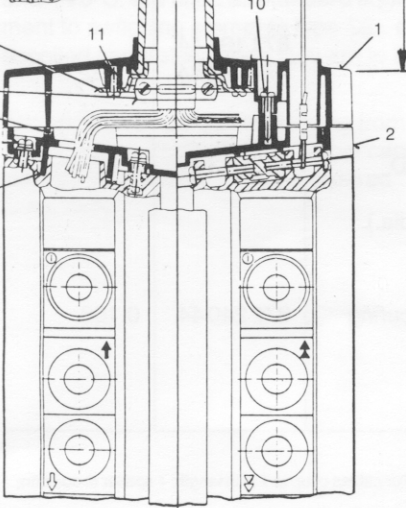
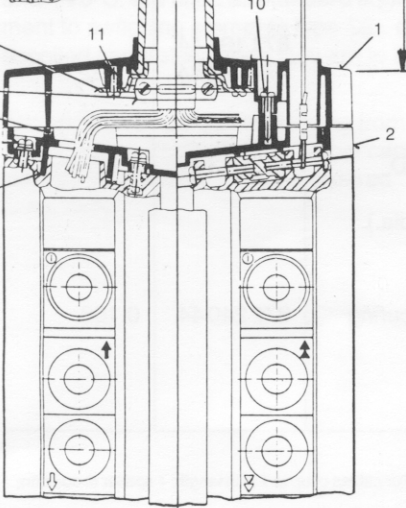
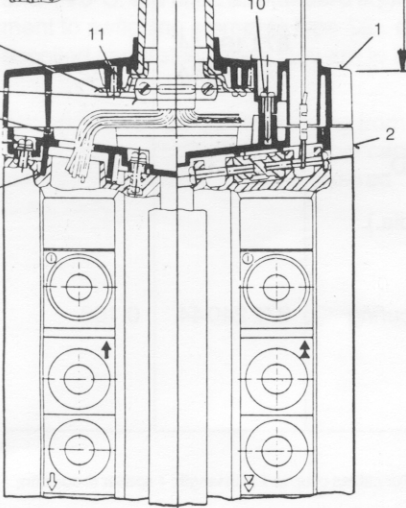
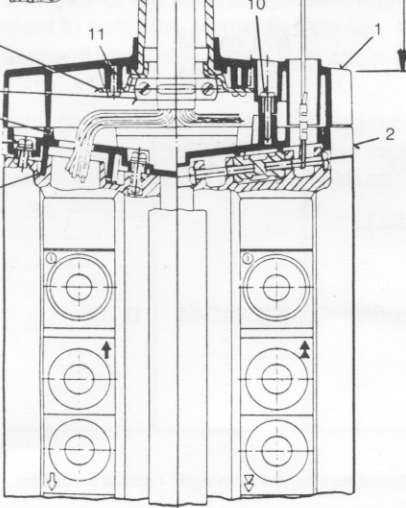
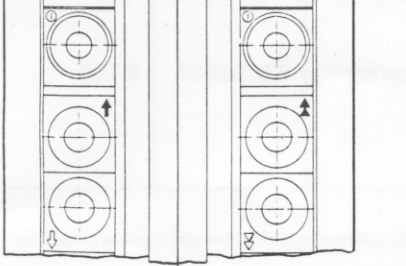
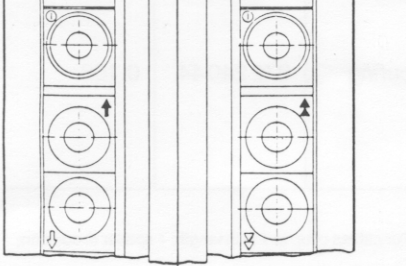
	Type	Designation	Part No.	Weight kg
 <p>ANZ-1</p>	DST 3	Modification set "protective sleeve against kinking" (to replace, for traction relief, flexible tube by strainer cords).	874 217 44	0.170
 <p>Dematik ANZ-1</p>	Dematik ANZ-1	Module for load display (for use in DST 6 or DST 9). (For load indicator and load detector see leaflets 206 086 44 and 206 203 44.)	469 318 44	0.095
 <p>Wall fixture</p>	YMHYck-T-O	Plastic-sheathed flexible cable 21 x 1.5 + 3 x 0.5, screened, as control cable for DST with display module 469 318 44.	894 218 44	0.56/m
 <p>DST-K</p>	DST-W	DST wall fixture cpl., for DST. In the wall fixture, the DST may be rigidly mounted or retained in position by means of a leaf spring. Rigid mounting is only permissible for a DST used as stationary control panel. Prior to its use, a DST retained by a leaf spring must be detached from the wall fixture.	874 400 44	0.55
 <p>DST-K</p>	DST-K	Coupling components for two DST cpl., comprising items 1-11. One buffer must be ordered in addition for coupling two DST 9.	874 515 44	0.8
 <p>YMHYKT-0</p>	YMHYKT-0	Control cable with reinforced load-supporting sheath, -40°C to +70°C	874 514 44	0.31
 <p>YMHYkT-J</p>	YMHYkT-J	4 x 1.5	504 935 44	0.17/m
 <p>YMHYkT-J</p>	YMHYkT-J	6 x 1.5	504 936 44	0.19/m
 <p>YMHYkT-J</p>	YMHYkT-J	7 x 1.5	504 937 44	0.22/m
 <p>YMHYkT-J</p>	YMHYkT-J	8 x 1.5	504 938 44	0.26/m
 <p>YMHYkT-J</p>	YMHYkT-J	10 x 1.5	504 939 44	0.32/m
 <p>YMHYkT-J</p>	YMHYkT-J	12 x 1.5	504 940 44	0.40/m
 <p>YMHYkT-J</p>	YMHYkT-J	24 x 1.5	504 795 44	0.56/m
 <p>YMHYkT-JJ</p>	YMHYkT-JJ	18 x 1.5	504 946 44	0.50/m
 <p>YMHYkT-JJ</p>	YMHYkT-JJ	30 x 1.5	504 489 44	0.86/m

Identification plates for control pendant switch type DST

All plates have the identification printed on either side.

Side a):
Yellow background with black symbol
Side b):
Black ground with yellow symbol

Colour:
Silken yellow (acc. to RAL 1007)
Silken black (acc. to RAL 9005)

Double identification plates (only usable for openings 2/3, 4/5, 6/7, and 8/9)

Designation:	Hoist (v1)	Hoist (v2)	Cross/long travel (v1)	Cross/long travel (v1 + v2)	Slewing (slewing gear crab)	Slewing (pillar slewing crane)	ON-OFF
Front side							
Designation	Hoist (v1 + v2)	Cross/long travel (v2)	Cross/long travel (v1)	Cross/long travel (v1 + v2)	Cross/long travel (v2)	Slewing (pillar slewing crane) (v1 + v2)	
Rear side							
Part No.	874 055 44	874 056 44	874 057 44	874 058 44	874 059 44	874 060 44	874 061 44

Double identification plate left blank: part No. 874 062 44³⁾

Cut double identification plate (left blank) in the middle when single blank identification plates are required.³⁾

Simple identification plates ¹⁾

Designation:	Horn	Latching	Inching	Lighting	Testing	Selection	ON ²⁾ (Emergency cut-out)
Front side							
Rear side							
Part No.	874 069 44	874 063 44	874 064 44	874 065 44	874 066 44	874 067 44	874 068 44

¹⁾ Single identification plates can be mounted as required so that either the front or rear side is seen.

²⁾ Black background; symbol, ring, and rear side yellow.

³⁾ Indicate text for engraving, if any (1 line of up to 12 characters, 4 mm in height) on order form 212 399 44.

Alterations reserved